

OPERATOR MANUAL

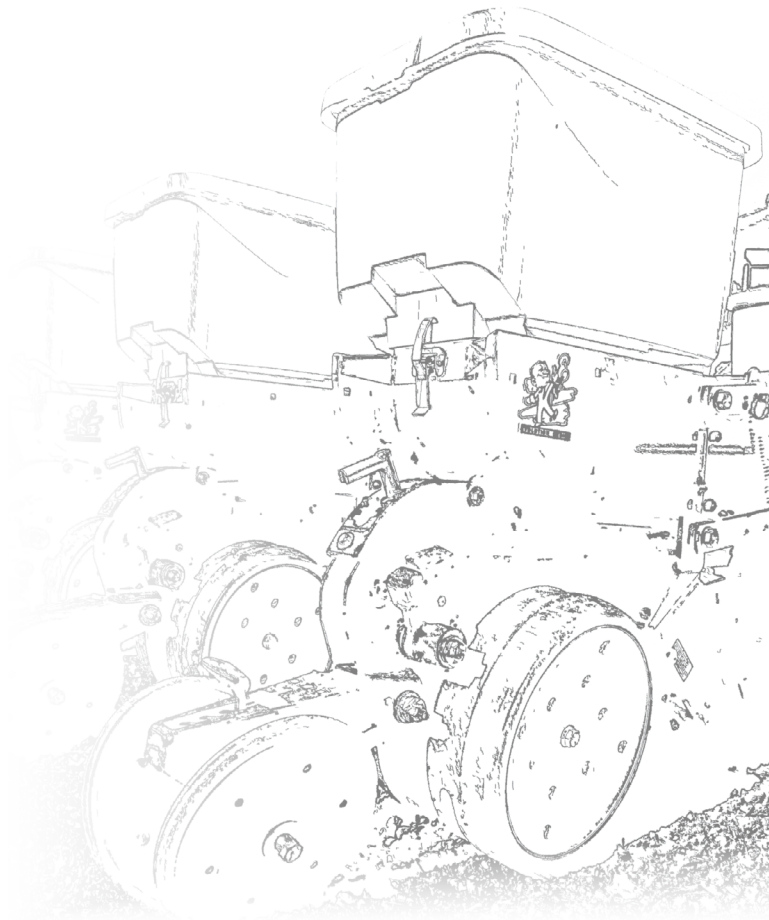

MKE002-01
MODEL 3030 70 CM NARROW FOLD PLANTER

02/20

MODEL 3030 70 CM NARROW FOLD PLANTER

OPERATOR MANUAL

MKE002-01

02/20

This manual applies to: Model: 3030 Narrow Fold Planters
Production Year 2020 and on

Record serial number of your planter and date purchased:

Model Number 3030

Serial Number _____

Date Purchased _____

Monitor Serial Number _____
Measured Pulses Per Mile/Km (Radar Distance Sensor) _____
Measured Pulses Per Mile/ Km (Magnetic Distance Sensor) _____

SERIAL NUMBER

The serial number plate is located on the L. H. side wing, underneath the outer fertilizer tank, as shown below. The serial number provides important information about your planter and is needed to obtain correct replacement parts. Always provide model number and serial number to your Kinze Dealer when ordering parts or when contacting Kinze Manufacturing, Inc.



Serial number plate



EUROPEAN DECLARATION OF CONFORMITY

Kinze Manufacturing
2172 M Avenue
Williamsburg, IA 53261

Kinze Europe UAB
Guopstu k., Senuju Traku sen
LT-21148 Traku r., Lithuania

We, Kinze Manufacturing and Kinze Europe UAB declare, under our sole responsibility, the following products – agricultural planter models 3000, 3030, 3110, 3140, 3200, 3500, 3600, 3700 and 4900 – to which this declaration relates, are in conformity with the following standards, other normative documents and Directives, as applicable by version and model:

2006/42/EC; EN 1037:1995+A1:2008; EN ISO 13850:2008; EN ISO 13857:2008; EN 349:1993+A1:2008; EN 547-1:1996+A1:2008; EN 547-2:1996+A1:2008; EN 547-3:1996+A1:2008; EN ISO 13732-1:2008; EN 614-1:2006+A1:2009; EN 614-2:2000+A1:2008; EN 953:1997+A1:2009; EN ISO 13849-1:2008; EN ISO 13849-2:2012; EN ISO 4254-1; EN ISO 12100:2010; EN ISO 4413:2010.

The Technical Construction File is maintained at: Kinze Manufacturing, Inc., 2172 M Avenue, Williamsburg, Iowa, USA, 52361-0806.

The authorized representative located within the community is: Edvardas Melys, Kinze Europe UAB, Guopstu k., Senuju Traku sen, LT-21148 Traku r., Lithuania.

Place of Issue: Kinze Manufacturing Inc., Williamsburg, Iowa, USA.

Date of Issue: 20160525 | May 25, 2016 | modified 20200225

Signed on behalf of Kinze Manufacturing Inc. and Kinze Europe UAB:

Jay D. Grimes



Corporate Counsel
Williamsburg, IA, USA

Kinze Manufacturing, Inc.

TO THE DEALER

Predelivery service includes assembly, lubrication, adjustment, and test. This service makes sure planter is delivered to the retail customer/end user ready for field use.

PREDELIVERY CHECKLIST

Use the following checklist and inspect planter after it is completely assembled. Check off each item found satisfactory or after proper adjustment is made.

- Row units properly spaced and optional attachments correctly assembled.
- All grease fittings in place and lubricated.
- All working parts are moving freely. Bolts are tight and cotter pins are spread.
- All drive chains properly tensioned and aligned.
- Check for oil leaks and proper hydraulic operation.
- Hydraulic hoses are routed correctly to prevent damage to hoses.
- Inflate tires to specified air pressure. Tighten wheel lug bolts to specified torque.
- All safety decals correctly located and legible as shown in Parts Manual. Replace if damaged.
- All reflective decals and SMV sign correctly located as shown in Parts Manual and visible when the planter is in transport position.
- Safety/warning lights correctly installed and working properly.
- Paint all parts scratched in shipment or assembly.
- All safety lockup devices are on planter and correctly located.
- Seed meters performance checked on test stand.
- Auxiliary safety chain properly installed and hardware torqued to specification.

This planter has been thoroughly checked and to the best of my knowledge is ready for delivery to the retail customer/end user.

(Signature Of Set-Up Person/Dealer Name/Date)

RETAIL CUSTOMER/END USER

Name _____ Delivery Date _____

Street Address _____ Model No. 3030 Serial No. _____

City, State/Province _____ Dealer Name _____

ZIP/Postal Code _____ Dealer No. _____

DELIVERY CHECKLIST

Use the following checklist when planter is delivered as a reminder of very important information which should be conveyed to the retail customer/end user. Check off each item as it is fully explained to the customer.

- Life expectancy of this or any other machine is dependent on regular lubrication as directed in the Operator Manual.
- All applicable safety precautions.
- Along with retail customer/end user, check that reflective decals and the SMV sign are clearly visible with planter in transport position and attached to tractor. Check safety/warning lights are in working condition. Instruct retail customer/end user to consult federal, state/provincial, and local regulations before towing or transporting on a road or highway.
- Give Operator Manual, Parts Manual, and all Instruction Sheets to the customer and explain all operating adjustments.
- Read warranty to customer.
- Complete Warranty and Delivery Report form.

To the best of my knowledge this machine has been delivered ready for field use and retail customer/end user has been fully informed as to proper care and operation.

(Signature Of Delivery Person/Dealer Name/Date)

AFTER DELIVERY CHECKLIST

The following is a list of items we suggest to check during the first season of use of the equipment.

- Check planter performance with retail customer/end user.
- Review importance of proper maintenance and adherence to all safety precautions with retail customer/end user.
- Check for parts that may need to be adjusted or replaced.
- Check that all safety decals, reflective decals, and the SMV sign are correctly located as shown in the Parts Manual and that decals are legible. Replace if damaged or missing.
- Check that safety/warning lights are working properly.

(Signature Of Follow-Up Person/Dealer Name/Date)

**All registrations must be submitted online at "business.kinze.com" within 5 business days of delivery.
Retain a copy of this form for auditing purposes.**

Tear Along Perforation

Contents

OVERVIEW

To the Owner 1-1
 Warranty 1-3
 Specifications 1-4
 Specifications 1-5
 General Safety Rules 1-6
 Safety Instructions, Signs, and Decals 1-7
 Safety Instructions, Signs, and Decals 1-8

MACHINE OPERATION

Initial Preparation 2-1
 Tractor Requirements 2-2
 Tractor Preparation and Hookup 2-3
 PTO Pump Drive and Oil Cooler Option 2-5
 OIL specification 2-5
 Cylinder Information 2-6
 Hydraulic Hose Information 2-7
 Hydraulic Operation 2-9
 Safety lockups 2-11
 Level Planter 2-11
 Transporting Planter 2-12
 Hydraulic Wing Fold Transport to Field Operation 2-13
 Hydraulic Wing Fold Field Operation to Transport 2-14
 Contact Drive Spring Adjustment 2-16
 Seed Rate Transmission Adjustment 2-17
 Standard and Half Rate (2 to 1) Drives 2-17
 Shear Protection 2-18
 Wrap Spring Wrench 2-19
 Tire Scraper 2-19
 Hydraulic Row Marker Operation 2-20
 Row Marker Speed Adjustment 2-21
 Row Marker Adjustments 2-22
 Digital Vacuum Readout 2-23
 Vacuum Fan Motor Valve Block Assembly 2-23
 Vacuum Meter System 2-23
 Analog Vacuum or Pressure Gauge 2-23
 Ridge Planting 2-24
 Planting Speed 2-24
 Field Test 2-25
 Check Seed Population 2-25
 Determining Kilograms Per Hectare (Brush-Type Meter) 2-26

ROW UNIT OPERATION

Planting Depth 3-1
 "V" Closing Wheel Adjustment (Rubber or Cast Iron) 3-1
 Closing Wheel Shield (Rubber or Cast Iron "V" Closing
 Wheels) 3-2

Brush-Type Seed Meter 3-3
 Finger Pickup Seed Meter 3-4
 Vacuum Settings 3-5
 Additives 3-8
 Seed Hopper 3-10
 Seed Meter Drive Release 3-10
 Row Unit Extension Brackets 3-10
 Row Unit Chain Routing 3-11
 Quick Adjustable Down Force Springs Option 3-12
 Frame Mounted Coulter 3-13
 Residue Wheels (for Frame Mounted Coulter) 3-13
 Row Unit Mounted Residue Wheel 3-14
 Spiked Closing Wheel 3-15
 Row Unit Mounted No Till Coulter 3-16
 Coulter Mounted Residue Wheels 3-16
 Granular Chemical Hopper and Drive 3-17
 Spring Tooth Incorporator 3-17
 Granular Chemical Banding Options 3-18
 Granular Chemical Bander Shield 3-18

FERTILIZER

Double Disc Fertilizer Opener 4-1
 Notched Single Disc Opener 4-2
 Depth/Gauge Wheel Attachment for Notched Single Disc
 Fertilizer Opener 4-3
 Dry Fertilizer Attachment 4-4
 Field Check Granular Chemical Application 4-5

RATE CHARTS 5-1

LUBRICATION AND MAINTENANCE

Lubrication 6-1
 Lubrication Symbols 6-1
 Sealed Bearings 6-1
 Wrap Spring Wrench Assembly 6-1
 Drive Chains 6-2
 Bushings 6-3
 Grease Fittings 6-4
 Mounting Bolts and Hardware 6-7
 Chain Tension Adjustment 6-10
 Finger Pickup Seed Meter Inspection/Adjustment 6-11
 Cleaning Finger Pickup Seed Meter For Storage 6-12
 Brush-Type Seed Meter Maintenance 6-13
 Cleaning Brush-Type Seed Meter For Storage 6-14
 Vacuum Seed Meter Maintenance 6-16
 Seed Meter Cleanout 6-16
 Gauge Wheel Adjustment 6-17
 Gauge Wheel Arm Bushing and/or Seal Replacement 6-18
 Gauge Wheel Arm Pivot Spindle Replacement 6-19

15" Seed Opener Disc Blade/Bearing Assembly 6-20

Seed Tube Guard/Inner Scraper 6-22

Row Unit Mounted Residue Wheel 6-23

Row Unit Mounted No Till Coulter 6-23

Coulter Mounted Residue Wheels 6-23

Spiked Closing Wheel 6-24

Granular Chemical Attachment 6-24

Row Marker Sequencing/Flow Control Valve Inspection 6-25

Row Marker Bearing Lubrication or Replacement 6-26

Wheel Bearing Repack or Replacement 6-27

Vacuum Check Valve Inspection 6-27

Vacuum Relief Valve Cartridge Inspection 6-27

Preparing Planter for Storage 6-28

Electrical Wiring Diagram for Light Package 6-29

Eu harness adapter Diagram (ISO 1724) 6-30

Hydraulic Hose Life 6-31

Hydraulic System Schematic 6-32

Hydraulic Schematic - Vacuum Fan Motor System 6-33

TROUBLESHOOTING 7-1

 Closing Wheel Troubleshooting 7-1

 Lift Circuit Operation Troubleshooting 7-2

 Row Marker Operation Troubleshooting 7-3

 PTO Pump Drive and Oil Cooler Option 7-3

 Seed Meter (Brush-Type) Troubleshooting 7-4

 Seed Meter (Finger Pickup) Troubleshooting 7-5





 Vacuum Seed Meter 7-6

Kinze Manufacturing, Inc. would like to thank you for your patronage. We appreciate your confidence in Kinze farm machinery. Your Kinze planter has been carefully designed to provide dependable operation in return for your investment.

This manual has been prepared to aid you in planter operation and maintenance. It should be considered a permanent part of the machine and remain with the machine when you sell it.

It is the responsibility of the user to read and understand this Operator Manual before operating this equipment. It is the user's responsibility to inspect and service the machine routinely as directed in this Operator Manual. We have attempted to cover all areas of safety, operation, lubrication and maintenance; however, there may be times when special care must be taken to fit your conditions.

Throughout this manual the symbol  and the words **DANGER**, **WARNING**, and **CAUTION** are used to call attention to safety information that if not followed, will or could result in death or injury. **NOTICE** and **NOTE** are used to call your attention to important information. The definition of each of these terms follows:

	<p>Indicates an imminently hazardous situation that, if not avoided, will result in death or serious injury. This signal word is to be limited to the most extreme situations, typically for machine components which, for functional purposes, cannot be guarded.</p>
	<p>Indicates a potentially hazardous situation that, if not avoided, could result in death or serious injury, and includes hazards that are exposed when guards are removed. It may also be used to alert against unsafe practices.</p>
	<p>Indicates a potentially hazardous situation that, if not avoided, may result in minor or moderate injury. It may also be used to alert against unsafe practices.</p>
	<p>Used to address safety practices not related to personal injury.</p>

NOTE: Special point of information or machine adjustment instructions.

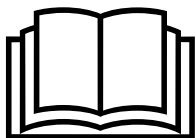

Improperly operating or working on this equipment could result in death or serious injury. Read and follow all instructions in Operator Manual before operating or working on this equipment.



Some photos in this manual may show safety covers, shields, or lockup devices removed for visual clarity. **NEVER OPERATOR OR WORK ON** machine without all safety covers, shields, and lockup device in place as required.

NOTE: Photos in this manual may be of prototype machines. Production machines may vary in appearance.

NOTE: Some photos and illustrations in this manual show optional attachments installed. Contact your Kinze Dealer for purchase of optional attachments.

The Kinze Limited Warranty for your new machine is stated on the retail purchaser's copy of the Warranty And Delivery Receipt form. Additional copies of the Limited Warranty can be obtained through your Kinze Dealer.

Warranty, within the warranty period, is provided as part of Kinze's support program for registered Kinze products which have been operated and maintained as described in this manual. Evidence of equipment abuse or modification beyond original factory specifications will void the warranty. Normal maintenance, service and repair is not covered by Kinze warranty.

To register your Kinze product for warranty, a Warranty And Delivery Receipt form must be completed by the Kinze Dealer and signed by the retail purchaser, with copies to the Dealer, and to the retail purchaser. Registration must be completed and submitted to Kinze Manufacturing, Inc. within 5 business days of delivery of the Kinze product to the retail purchaser. Kinze Manufacturing, Inc. reserves the right to refuse warranty on serial numbered products which have not been properly registered.

If service or replacement of failed parts which are covered by the Limited Warranty are required, it is the user's responsibility to deliver the machine along with the retail purchaser's copy of the Warranty And Delivery Receipt to the Kinze Dealer for service. Kinze warranty does not include cost of travel time, mileage, hauling or labor. Any prior arrangement made between the Dealer and the retail purchaser in which the Dealer agrees to absorb all or part of this expense should be considered a courtesy to the retail purchaser.

Kinze warranty does not include cost of travel time, mileage, hauling or labor.



3030 Narrow Fold with Dry Fertilizer Option

GENERAL INFORMATION

This manual covers all production years of the Model 3030 planter. Contact your Kinze dealer for additional options which may be available for your specific model year planter.

Information in this manual was current at time of printing. However, due to Kinze's ongoing product improvement, production changes may cause your machine to appear slightly different in detail. Kinze Manufacturing, Inc. reserves the right to change specifications or design without notice and without incurring obligation to install the same on machines previously manufactured. To obtain the most recent version of your publication, please contact your Kinze dealer.

Right hand (R.H.) and left hand (L.H.), as used throughout this manual, are determined by facing in the direction the machine will travel when in use, unless otherwise stated.

TOOLS REQUIRED

Hardware Size / Tool Required			
$\frac{1}{4}'' = \frac{7}{16}''$	$\frac{7}{16}'' = \frac{5}{8}''$ (nut for $\frac{7}{16}''$ hardware uses $\frac{11}{16}''$ tool)	$\frac{3}{4}'' = 1\frac{1}{8}''$	$1\frac{1}{4}'' = 1\frac{7}{8}''$
$\frac{5}{16}'' = \frac{1}{2}''$	$\frac{1}{2}'' = \frac{3}{4}''$	$\frac{7}{8}'' = 1\frac{5}{16}''$	$1\frac{1}{2}'' = 2\frac{1}{4}''$
$\frac{3}{8}'' = \frac{9}{16}''$	$\frac{5}{8}'' = 1\frac{5}{16}''$	$1'' = 1\frac{1}{2}''$	

SPECIFICATIONS

Planter Size	8 Row 70 CM
Length - Planting	6,77 m
Length - Transport	6,59 m
Width - Planting	5,50 m
Width - Transport	3,00 m
Height - Planting	2,8 m
Height - Transport	3,22 m
Weight - Base Machine*	2830 kg
* Weight dependent upon equipment (meters, drive, other options, etc.)	
Seed Capacity	1.75 bu (~62 l)/Hopper (Vacuum); 1.9 bu (~67 l)/Hopper (Mechanical)
Transport/Field Tire	Four 7.50" x 20" 8 ply rib implement tires w/ center groove - Inflate to 40 PSI (~2,76 bar)
Contact Drive Tire	Two 4.10" x 6" spring-loaded contact drive tires. - Inflate to 50 PSI (~3,45 bar)
Field Lift	Master / slave rephasing cylinders
Row Markers	Hydraulic alternating sequence valve (dual valve optional), single fold, depth bands.



TRACTOR HYDRAULIC REQUIREMENTS

Configuration	Requirements		Description
Base machine with mechanical meters and row markers	2 SCV	10 gpm (38 l/min)	#1 SCV: Planter lift and row marker auto sequencing
Base machine with vacuum meters and row markers	3 SCV	20 gpm (76 l/min)	#1 SCV: Planter lift and row marker auto sequencing #2 SCV: Vacuum fan

1. Read and understand instructions provided in this manual and warning labels. Review these instructions frequently!
 2. This machine is designed and built with your safety in mind. Do not make any alterations or changes to this machine. Any alteration to design or construction may create safety hazards.
 3. A large portion of farm accidents happen from fatigue or carelessness. Safe and careful operation of tractor and planter will help prevent accidents.
 4. Never allow planter to be operated by anyone unfamiliar with operation of all functions of the unit. Operators must read and thoroughly understand all instructions given in this manual before operating or working on equipment.
 5. Be aware of bystanders, particularly children! Always look around to make sure it is safe to start tow vehicle engine or move planter. This is particularly important with higher noise levels and quiet cabs, as you may not hear people shouting.
 6. Make sure planter weight does not exceed towing capacity of tractor, or bridge and road limits. This is critical to maintain safe control and prevent death or injury, or property and equipment damage.
 7. Never ride or allow others to ride on planter.
 8. Store planter in an area away from human activity. DO NOT permit children to play on or around the stored unit.
 9. Keep hands, feet, and clothing away from moving parts. Do not wear loose-fitting clothing which may catch in moving parts.
 10. Always wear protective clothing, shoes, gloves, hearing, and eye protection applicable for the situation.
 11. Do not allow anyone to stand between tongue or hitch and towing vehicle when backing up to planter.
 13. Prevent electrocution, other injuries, or property and equipment damage. Watch for obstructions such as wires, tree limbs, etc. when operating machine. Be aware of clearances during turns and when folding/unfolding planter.
 14. Reinstall all guards removed for maintenance activities. Never leave guards off during operation.
 15. Use of aftermarket hydraulic, electric, or PTO drives may create serious safety hazards to you and people nearby. If you install such drives, follow all appropriate safety standards and practices to protect you and others near this planter from injury.
 16. Follow all federal, state/provincial, and local regulations when towing farm equipment on a public highway. Use safety chain (not an elastic or nylon/plastic tow strap) to retain connection between towing and towed machines in the event of primary attaching system separation.
 17. Make sure all safety/warning lights, SMV sign, and reflective decals are in place and working properly before transporting the machine on public roads.
 18. Limit towing speed to 24 km/h. Tow only with farm tractor of a minimum 90 HP. Allow for unit length when making turns.
 19. Reduce speed prior to turns to avoid the risk of overturning. Always drive at a safe speed relative to local conditions and ensure your speed is slow enough for a safe emergency stop.
 20. Chemical application is often an integral part of planting. Follow label instructions for proper chemical mixing, handling and container disposal methods.
 21. Be familiar with safety procedures for immediate first aid should you accidentally contact chemical substances.
 22. Use the proper protective clothing and safety equipment when handling chemicals.
 23. Chemicals are supplied with Material Safety Data Sheets (MSDS) that provide full information about the chemical, its effects on exposure, and first aid needs in the event of an emergency. Keep your MSDS file up-to-date and available for first responders in case of emergency.
 24. When servicing ground engaging components such as opening disks and firming points, use special care to avoid points and edges worn sharp during use.
 25. Use professional help if you are unfamiliar with working on hydraulic systems. Pressurized hydraulic fluid can penetrate body tissue and result in death, serious infection, or other injuries.
 26. Disposing of waste improperly can threaten the environment. To dispose of your equipment properly contact your local environmental or recycling center.
- Never pour waste onto the ground, down a drain, or into any water source.
- When disposing of waste such as oil, use leakproof containers. Be sure to use containers that do not resemble food or beverage which may mislead someone into consuming them. Dispose of oil per your local, regional requirements.
- When disposing of any fertilizer chemicals used, contact the supplier of the chemicals.
- Model 3030 planter consists of 85% recyclable metals, 10% recyclable plastic and rubber, and 5% waste.

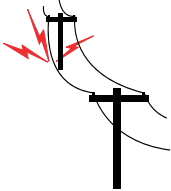

Following are some common hazard warnings associated with this equipment. Pay close attention to all safety, operating, and maintenance information in this manual and decals applied to your equipment.

	<p>Contacting or coming close to power lines or other high energy sources will cause death or serious injury.</p>
	<p>Keep away from power lines or high energy sources at all times.</p>

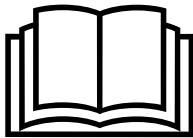
	<p>Loss of control can cause death or serious injury, or damage to property and equipment. Tow only with farm tractor weight rated and configured for this equipment. Use safety chains and transport as specified in the Operator and Parts Manual.</p>
	

	<p>Improperly operating or working on this equipment could result in death or serious injury. Read and follow all instructions in Operator Manual before operating or working on this equipment.</p>
	

	<p>Contact with rotating driveline will cause death or serious injury. Keep away at all times when operating.</p>
	<p>Never operate without all guards and equipment shields properly installed.</p>

	<p>Explosive separation of rim and tire parts can cause death or serious injury. Overinflation, rim and tire servicing, improper use of rims and tires, or worn or improperly maintained tires could result in a tire explosion.</p>
	

Safety Signs And Decals

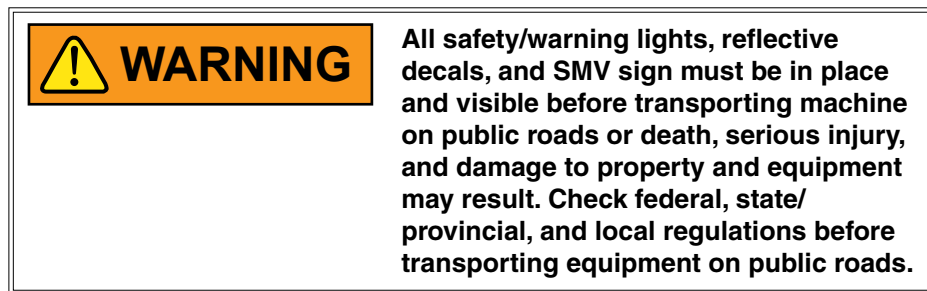

Safety signs and decals are placed on the machine to warn of hazards and provide important operating and maintenance instructions. Information on these signs are for your personal safety and the safety of those around you. FOLLOW ALL SAFETY INSTRUCTIONS!

- **Keep signs clean so they can be easily seen. Wash with soap and water or cleaning solution as required.**
- **Replace safety signs if damaged, painted over, or missing.**
- **Check reflective decals and SMV sign periodically. Replace if they show any loss of reflective properties.**
- **When replacing decals, clean machine surface thoroughly with soap and water or cleaning solution to remove all dirt and grease.**



NOTE: Safety sign and decal locations are shown in the Parts Manual for this machine.

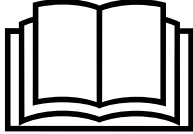

NOTE: Style and locations of SMV sign, reflective decals, and safety/warning lights conform to ANSI/ASABE S279.14 JUL 2008 and ANSI/ASABE S276.6 JAN 2005.

Following information is general in nature to aid in preparation of tractor and planter for use, and to provide general operating procedures. Operator experience, familiarity with the machine, and the following information should combine for efficient planter operation and good working habits.

 WARNING	<p>Improperly operating or working on this equipment could result in death or serious injury. Read and follow all instructions in Operator Manual before operating or working on this equipment.</p>
	

INITIAL PREPARATION

 WARNING	<p>Loose transport wheel lug bolts can result in wheel separation from planter and cause death, serious injury, and damage to property and equipment. Torque transport wheel $\frac{5}{8}$"- 18 lug bolts to 180 ft-lb (~244 Nm) before operating planter for the first time and periodically after.</p>
	

 WARNING	<p>Explosive separation of rim and tire parts can cause death or serious injury. Overinflation, rim and tire servicing, improper use of rims and tires, or worn or improperly maintained tires could result in a tire explosion.</p>
	

1. Torque transport wheel $\frac{5}{8}$ "- 18 lug bolts to 90 ft-lb (~122 Nm).
2. Inflate transport/ground drive tires to 40 PSI (2,76 bar).
3. Inflate contact drive tires to 50 PSI (3,45 bar).



TRACTOR REQUIREMENTS**NOTICE**

All Hydraulic Requirements: Minimum Pressure 2350 PSI (~16200 kPa); Maximum Pressure 3000 PSI (~20700 kPa). Check tractor hydraulics to ensure that maximum pressure cannot be exceeded.

Consult your dealer for information on horsepower requirements and tractor compatibility. Requirements vary with planter options, tillage, and terrain.

A 12 VDC electrical system is required for all 3030 series planters.

One dual remote hydraulic outlet (SCV) is required for machines equipped with a standard single valve hydraulic system. Two dual remote hydraulic outlets (SCV) are required for machines equipped with the optional dual valve hydraulic system.

Maximum hydraulic flow rate of 49 l @ 2000 PSI (~13800 kPa) is required (in addition to planter lift/marker hydraulic requirements) to operate the seed metering system vacuum fan motor.

NOTE: Connect hydraulic motor case drain to a case drain return line with zero bar on the tractor. Failure to connect to a return with zero bar will cause damage to the hydraulic motor shaft seal. Warranty will not apply on damaged motors resulting from improper hydraulic line connection. DO NOT connect hydraulic motor case drain to a SCV outlet or motor return circuit connection. Contact tractor manufacturer for specific details on “zero pressure return”.

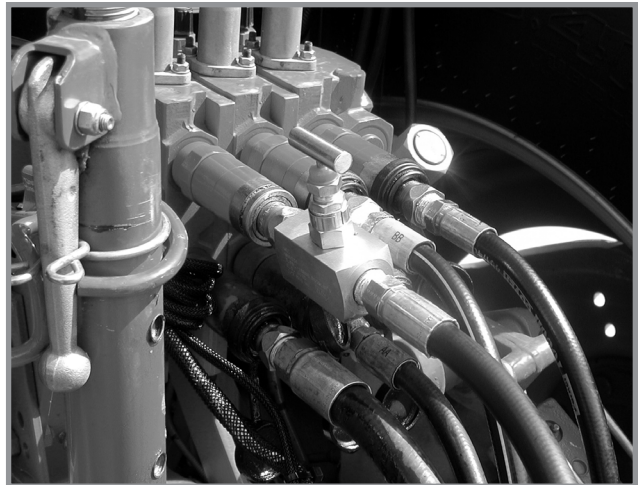

G1K426 Needle Valve Kit

TRACTOR PREPARATION AND HOOKUP

1. Adjust tractor drawbar 13 to 17 inches (~33 to 43 cm) above ground. Adjust drawbar so hitch pin hole is directly below center line of PTO shaft. Make sure drawbar is in a stationary position.
2. Back tractor to planter and connect with a minimum $\frac{3}{4}$ " (~2 cm) diameter hitch pin. Secure with a locking or cotter pin.

NOTE: DO NOT install safety chain using clevis mounting hardware. Safety chain MUST be installed separately.

3. Provided transport safety chain must be used to keep planter and tractor connected in case of a hitch pin/drawbar failure. Attach safety chain at an unused clevis mounting hole on the planter hitch. Torque hardware to 840 ft-lb (~1140 Nm).

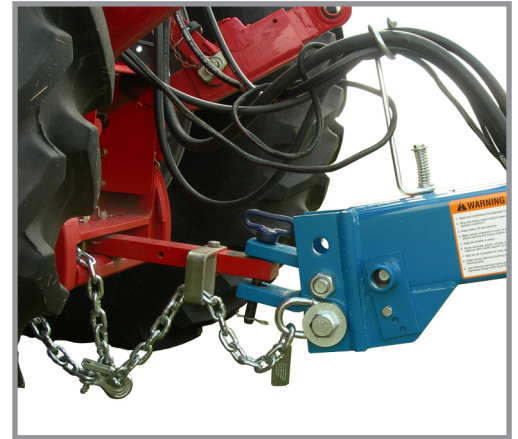

Drawbar and safety chain connection

NOTE: Improper connection could damage planter or tractor.

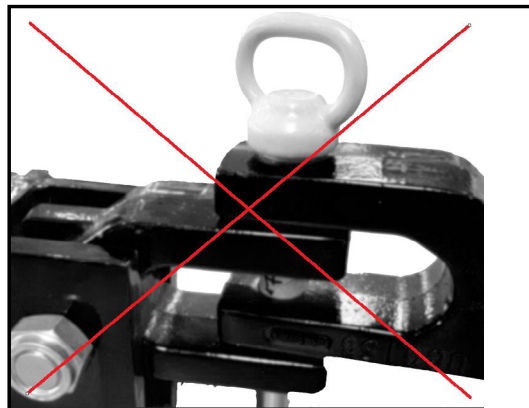

WARNING



Pressurized hydraulic fluid can penetrate body tissue and result in death, serious infection, or other injuries. Fluid injected under skin must be **IMMEDIATELY** removed by a surgeon familiar with this type of injury. Make sure connections are tight and hoses and fittings are not damaged before applying system pressure. Leaks can be invisible. Keep away from suspected leaks. Relieve pressure before searching for leaks or performing any system maintenance.

NOTICE

Wipe hose ends to remove any dirt before connecting couplers to tractor ports or contamination may cause equipment failure.

- Connect hydraulic hoses to tractor ports in a sequence familiar and comfortable to the operator.

The vacuum fan motor hydraulic hoses are as follows:

3/8" Hose From Motor	Case Drain
1/2" Hose To Motor	Pressure
5/8" Hose From Motor	Motor Return

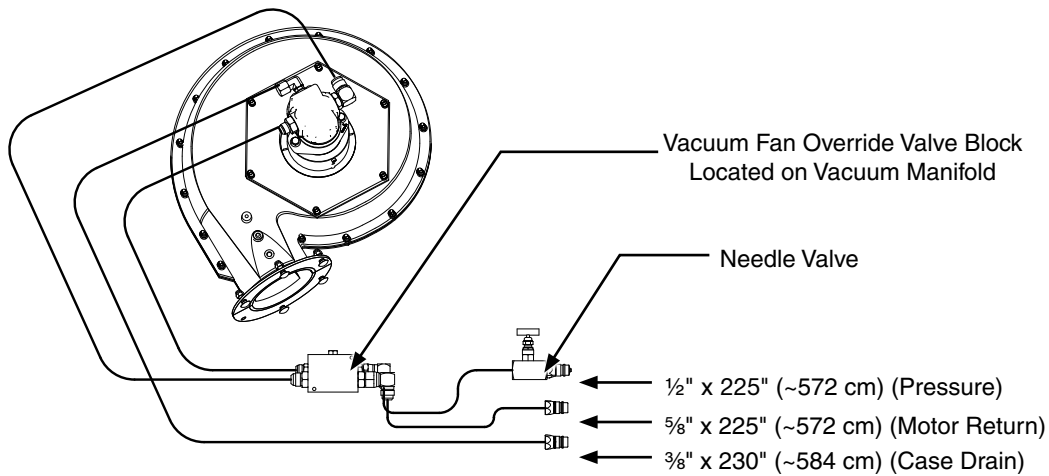

NOTE: If tractor is equipped with an adjustable flow outlet (SCV), set to full flow position.

- Connect ASABE Standards 7 terminal connector for safety/warning lights on planter to ASABE Standards receptacle on tractor. If your tractor is not equipped with an ASABE Standards receptacle, check with your tractor manufacturer for availability. Check warning lights on planter work in conjunction with warning lights on tractor.

Connect harness on planter to digital vacuum gauge console on tractor. Connect power lead to power source. A power lead adapter may be required.



Jack stand installed



Jack stand stored

- Raise jack stand and remount horizontally on storage bracket.

PTO Pump Drive and Oil Cooler Option

The tractor mounted PTO pump and oil cooler option is for Belarus MTZ 80/82 tractors with less than required hydraulic output needed to operate hydraulic-driven vacuum fan and other planter hydraulic requirements.

A 1000 RPM PTO is required to operate the PTO-driven hydraulic pump.

PTO pump option consists of a special Belarus MTZ 80/82 mounting adapter and 56 l/min 2000 PSI tractor mounted pump, planter mounted 60 l capacity hydraulic reservoir with 25-micron oil filter, vacuum fan mounted 130 l/min -rated oil cooler, and required hydraulic valves, fittings, and hoses.



OIL SPECIFICATION

Hydraulic transmission oil is used in the planter and PTO. The oil chemical properties:

Viscosity, mm ² /s @ 100 °C. ASTM D-445	10
Viscosity, mm ² /s @ 40 °C. ASTM D-445	63
Viscosity Index ASTM D-2270	143
TBN, mg KOH/g ASTM D-2896	9
TAN, mg KOH/g (ASTM D-664)	2
Pour Point, °C ASTM D-5950	-42
Specific Gravity @ 15.6°C. ASTM D-4052	0,876
Flash Point, COC, °C. ASTM D-92	220

NOTE: Factory filled with VALVOLINE™ UNITRAC SAE 80W.

CYLINDER INFORMATION

Description	Row Marker Cylinder	Slave Lift Cylinder	Master Lift Cylinder	Hydraulic Wing Fold Cylinder
Intended Use	Double Acting Applications	Double Acting Applications	Double Acting Applications	Double acting applications
Piston	Ductile Iron	Ductile Iron	Ductile Iron	Ductile iron
Gland	Ductile Iron	Ductile Iron	Ductile Iron	Ductile iron
Tube	ST 52 DOM Tubing	ST 52 DOM Tubing	ST 52 DOM Tubing	ST 52 Dom
Rod	1045 Nitro Rod	1045 Nitro Rod	1045 Nitro Rod	1045 Nitro rod
End Mounts	Sleeve End Mount	Sleeve Trunnion Mount	Sleeve Trunnion Mount	Tang
Tube Seal	Buna O-Ring with Polytemp Back-up	Buna O-Ring with Polytemp Back-up	Buna O-Ring with Polytemp Back-up	Buna O-Ring with polytemp back-up
Rod Seal	Polyester Alloy U-cup	Polyester Alloy U-cup	Polyester Alloy U-cup	Polyester alloy u-cup
Rod Wiper	Polyester Alloy Snap In	Polyester Alloy Snap In	Polyester Alloy Snap In	Polyester alloy snap in
Piston Seal	T-seal HNBR	T-Seal HNBR	T-Seal HNBR	T-seal HNBR
Specifications				
Product Category	Hydraulic Cylinder	Hydraulic Cylinder	Hydraulic Cylinder	Hydraulic Cylinder
Maximum Stroke	20.62" (~5,24 cm)	8" (~2,03 cm)	8" (~2,03 cm)	406 mm
Working Pressure	3000 PSI (~20700 KPa)	3000 PSI (~20700 KPa)	3000 PSI (~20700 KPa)	209 bar (3000 PSI)
Bore Size	2" (~5,10 cm)	3.25" (~8,30 cm)	3.5" (~8,90 cm)	76 mm
Shaft Diameter	1" (~2,50 cm)	1.25" (~3,20 cm)	1.25" (~3,20 cm)	32 mm
Cylinder Configuration	Simple	Simple	Simple	Simple
Cylinder Action	Double	Double	Double	Double
Material	Steel, Ductile Iron	Steel, Ductile Iron	Steel, Ductile Iron	Steel, Ductile Iron
Mounting Method	Sleeve	Sleeve Trunnion Mount	Sleeve Trunnion Mount	Tang
Mount Location	End Cap	End Cap	End Cap	End Cap
Cylinder Style	Welded	Welded	Welded	Welded

HYDRAULIC HOSE INFORMATION

Part Number	A3134	A1036	A1030	A3137	A1000	A1154
Description	Hose Assembly, 3/8" x 198" (~502,9 cm)	Hose Assembly, 3/8" x 280" (~711,2 cm)	Hose Assembly, 3/8" x 192" (~487,7 cm)	Hose Assembly, 3/8" x 140" (~355,6 cm)	Hose Assembly, 3/8" x 15" (~38,1 cm)	Hose Assembly, 1/4" x 72" (~182,9 cm)
Product Category	Hydraulic Hose	Hydraulic Hose	Hydraulic Hose	Hydraulic Hose	Hydraulic Hose	Hydraulic Hose
Product Form	Hose; Assembly	Hose; Assembly	Hose; Assembly	Hose; Assembly	Hose; Assembly	Hose; Assembly
I.D.	3/8" (~9,53 mm)	3/8" (~9,53 mm)	3/8" (~9,53 mm)	3/8" (~9,53 mm)	3/8" (~9,53 mm)	1/4" (~6,35 mm)
O.D.	.69" (17,53 mm)	.69" (17,53 mm)	.69" (17,53 mm)	.69" (17,53 mm)	.69" (17,53 mm)	.53" (~13,46 mm)
Minimum Bend Radius	2.5" (~63,50 mm)	2.5" (~63,50 mm)	2.5" (~63,50 mm)	2.5" (~63,50 mm)	2.5" (~63,50 mm)	4" (~101,60 mm)
Working Pressure	3000 PSI (~20684 kPa)	3000 PSI (~20684 kPa)	3000 PSI (~20684 kPa)	3000 PSI (~20684 kPa)	3000 PSI (~20684 kPa)	3275 PSI (~22600 kPa)
Temperature Range	-40°C - +100°C	-40°C - +100°C	-40°C - +100°C	-40°C - +100°C	-40°C - +100°C	-40°C - +100°C
Material	Modified Nitrile Type C2	Modified Nitrile Type C2	Modified Nitrile Type C2	Modified Nitrile Type C2	Modified Nitrile Type C2	Modified Nitrile Type C2
Specialized Construction	High tensile steel wire	High tensile steel wire	High tensile steel wire	High tensile steel wire	High tensile steel wire	High tensile steel wire
Media	Hydraulic Fluid	Hydraulic Fluid	Hydraulic Fluid	Hydraulic Fluid	Hydraulic Fluid	Hydraulic Fluid
Application	Agricultural; Construction	Agricultural; Construction	Agricultural; Construction	Agricultural; Construction	Agricultural; Construction	Agricultural; Construction

Part Number	A15050	A3133	A15086-209	A15092-25	A21518-225	A18684-225
Description	Hose Assembly, 3/8" x 230" (~584,2 cm)	Hose Assembly, 3/8" x 191" (~485,1 cm)	Hose Assembly, 3/8" x 209" (~530,9 cm)	Hose Assembly, 3/8" x 25" (~63,5 cm)	Hose Assembly, 5/8" x 225" (571,5 cm)	Hose Assembly, 1/2" x 225" (571,5 cm)
Product Category	Hydraulic Hose	Hydraulic Hose	Hydraulic Hose	Hydraulic Hose	Hydraulic Hose	Hydraulic Hose
Product Form	Hose; Assembly	Hose; Assembly	Hose; Assembly	Hose; Assembly	Hose; Assembly	Hose; Assembly
I.D.	3/8" (~9,53 mm)	3/8" (~9,53 mm)	3/8" (~9,53 mm)	3/8" (~9,53 mm)	5/8" (~15,87 mm)	1/2" (~12,70 mm)
O.D.	.69" (17,53 mm)	.69" (17,53 mm)	.69" (17,53 mm)	.69" (17,53 mm)	.94" (~23,87 mm)	0.81" (~20,57 mm)
Minimum Bend Radius	2.5" (~63,50 mm)	2.5" (~63,50 mm)	2.5" (~63,50 mm)	2.5" (~63,50 mm)	4" (~101,60 mm)	3.5" (~88,90 mm)
Working Pressure	3000 PSI (~20684 kPa)	3000 PSI (~20684 kPa)	3000 PSI (~20684 kPa)	3000 PSI (~20684 kPa)	2750 PSI (~18960 kPa)	3000 PSI (~20684 kPa)
Temperature Range	-40°C - +100°C	-40°C - +100°C	-40°C - +100°C	-40°C - +100°C	-40°C - +100°C	-40°C - +100°C
Material	Modified Nitrile Type C2	Modified Nitrile Type C2	Modified Nitrile Type C2	Modified Nitrile Type C2	Modified Nitrile Type C2	Modified Nitrile Type C2
Specialized Construction	High tensile steel wire	High tensile steel wire	High tensile steel wire	High tensile steel wire	High tensile steel wire	High tensile steel wire
Media	Hydraulic Fluid	Hydraulic Fluid	Hydraulic Fluid	Hydraulic Fluid	Hydraulic Fluid	Hydraulic Fluid

Application	Agricultural; Construction	Agricultural; Construction	Agricultural; Construction	Agricultural; Construction	Agricultural; Construction	Agricultural; Construction
--------------------	-------------------------------	-------------------------------	-------------------------------	-------------------------------	-------------------------------	-------------------------------

Hydraulic Hose Information (Continued)

Part Number	A15086-216	A15092-16.25				
Description	Hose Assembly, 3/8" x 216" (~548,6 cm)	Hose Assembly, 3/8" x 16.25" (~41,3 cm)				
Product Category	Hydraulic Hose	Hydraulic Hose				
Product Form	Hose; Assembly	Hose; Assembly				
I.D.	3/8" (~9,53 mm)	3/8" (~9,53 mm)				
O.D.	.69" (17,53 mm)	.69" (17,53 mm)				
Minimum Bend Radius	2.5" (~63,50 mm)	2.5" (~63,50 mm)				
Working Pressure	3000 PSI (~20684 kPa)	3000 PSI (~20684 kPa)				
Temperature Range	-40°C - +100°C	-40°C - +100°C				
Material	Modified Nitrile Type C2	Modified Nitrile Type C2				
Specialized Construction	High tensile steel wire	High tensile steel wire				
Media	Hydraulic Fluid	Hydraulic Fluid				
Application	Agricultural; Construction	Agricultural; Construction				

HYDRAULIC OPERATION

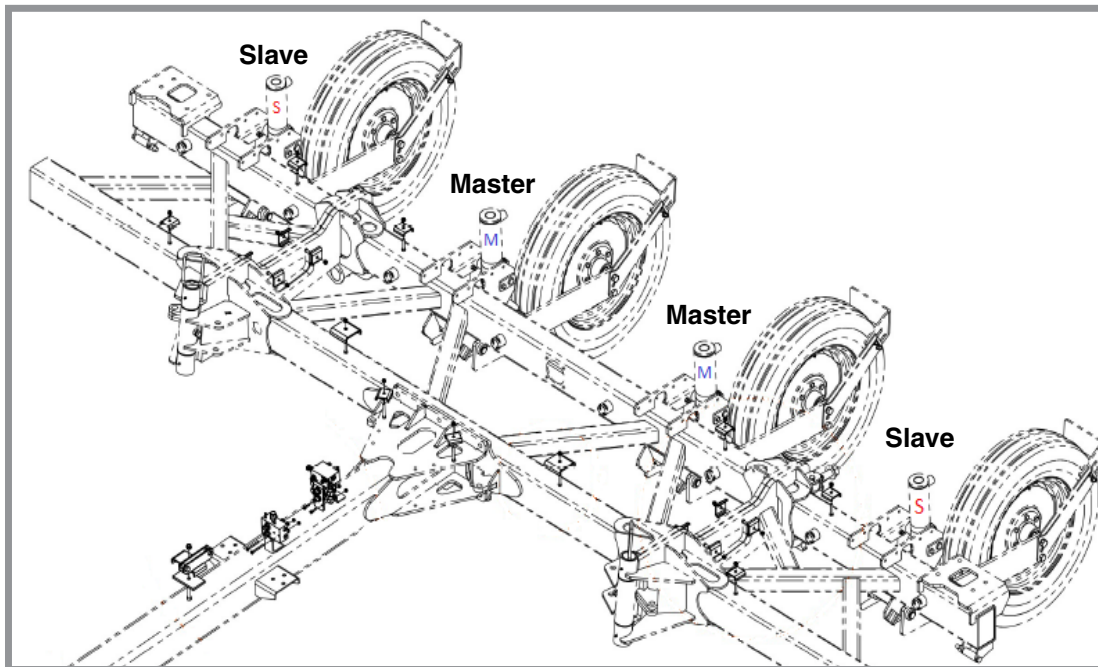
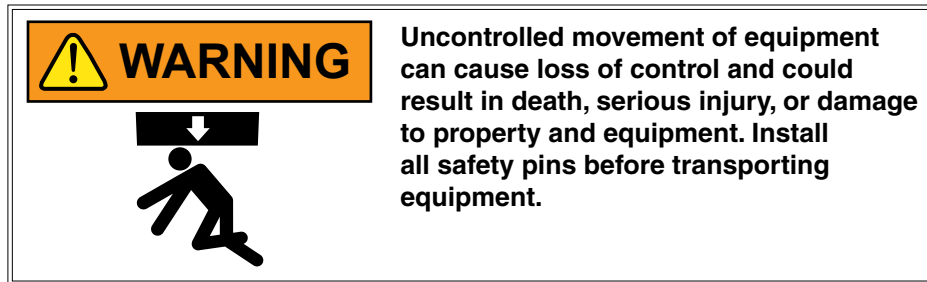

Lift cylinder locations

PLANTER LIFT SYSTEM

The planter lift system consists of 2 master cylinders and 2 slave cylinders in a Slave->Master->Master->Slave physical arrangement going from L.H. side of the planter to R.H. side (for a detailed hydraulic configuration, see ["Hydraulic System Schematic" on page 6-32](#)).

With a master/slave hydraulic lift system, oil is forced into the butt end of master and lift assist cylinders when the hydraulic lever on the tractor is moved to the raise position. As the master cylinder extends, oil from the master cylinder rod end is forced into the slave cylinder butt end. Displacement on the master cylinder rod end is equal to displacement on the slave cylinder butt end. This causes the two cylinders to move at the same rate so the planter raises and lowers evenly.

Note: Planter lifts unevenly if lift cylinders are out of phase. A valve in the piston of each master and slave cylinder allows system to rephase when cylinders are cycled by lowering planter to ground and holding hydraulic lever for 5-10 seconds. Cycle system until planter lifts and lowers evenly.

ROW MARKERS

All Model 3030 planters are equipped with a dual valve hydraulic system which allows row markers to be operated independently of planter lift cylinders. Row markers are controlled on alternating sides through a tractor SCV. A sequencing valve directs flow to marker on opposite side each time a row marker is raised. When lower row marker is selected, row marker on opposite side of row marker last raised is lowered. Both row markers can also be down at the same time. Lower planter and row marker.

Marker hydraulic system includes two flow control valves. One flow control valve sets lowering speed and one sets raising speed of both markers.

FOLD CYLINDERS WITH SELECTOR VALVE

A hitch mounted, hand operated selector valve selects row marker or fold functions. Fold cylinders are mounted on each side of the front frame and fold wings to/from transport position. Row marker cylinders raise and lower row markers.

NOTE: Hydraulic pressure will prevent valves from moving. Release hydraulic pressure from system before attempting to move selector valve handle.



Hitch-mounted selector valve

SAFETY LOCKUPS

Safety lockups are provided for two center cylinders and must be in place when working on a raised planter, transporting, or during storage.



Safety lockup installed

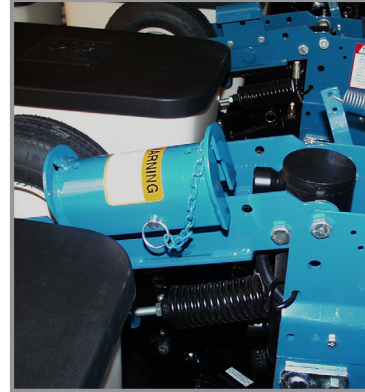

Safety lockup in storage location

Place a safety lockup on each cylinder rod and secure in place with pin. Keep safety lockups in storage locations on planter when not in use.

LEVEL PLANTER

Lateral adjustment is maintained by tire pressure. Check tires are inflated to specification.

Front and rear level adjustment is maintained by hitch clevis position unless tractor drawbar is adjustable for height. Planter frame and row unit parallel arms must be level for proper planter and row unit operation. Bottom of toolbar should be 20" to 22" (~50 to 56 cm) from planting surface.

1. Lower planter to planting position and check planter is level front to rear. Go to step 2 if hitch is too high or low.

NOTE: DO NOT install safety chain using clevis hardware. Move safety chain location if necessary.

2. Remove clevis hitch hex head cap screw and lock nut using a torque wrench. Replace if off-torque is below 75 ft-lb (~102 Nm) or there is corrosion or damage.

NOTE: Clevis must be free to move on hitch. DO NOT OVERTIGHTEN hardware.

3. Align clevis to hitch holes at new location and install hex head cap screw and lock nut. Tighten lock nut until threads are fully engaged and hex head cap screw and lock nut are firmly against hitch bracket.
4. Recheck with planter in field.

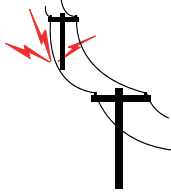
TRANSPORTING PLANTER**DANGER**

Contacting or coming close to power lines or other high energy sources will cause death or serious injury.

Keep away from power lines or high energy sources at all times.

**WARNING**

All safety/warning lights, reflective decals, and SMV sign must be in place and visible before transporting machine on public roads or death, serious injury, and damage to property and equipment may result. Check federal, state/provincial, and local regulations before transporting equipment on public roads.

**WARNING**

NEVER transport the planter loaded with seeds/fertilizer, as that will likely result in serious damage to the equipment and personal injury of machine operator and any bystanders. **ONLY** load the planter with seeds/fertilizer when in the field.



Tow only with farm tractor rated and configured for the equipment.



Know your route and be aware of any obstructions.



Follow all road and bridge load limit restrictions, as well as local traffic laws.



Never exceed the maximum transport towing speed of 12 mph (~20 km/h).

HYDRAULIC WING FOLD TRANSPORT TO FIELD OPERATION



Planter wings may swing suddenly and cause death or serious injury. Do not stand between wings and frame when folding or unfolding planter. Planter must be on a level surface in all directions.

SUMMARIZED TRANSPORT TO FIELD SEQUENCE

- With center lift cylinders retracted and lockups in place, remove wing lock pins.
- Move selector valve to "FOLD".
- Hydraulically fold wings out.
- Swing wing locking eyebolts into place.
- Extend lift cylinders.
- Remove center section lift cylinder lockups.
- Lower planter.
- Tighten wing locking eyebolts.
- Move selector valve to "MARKER".

NOTE: Read following information for detailed instructions.

NOTE: Use special wrench stored on inside of hitch for center turnbuckle and wing lock eyebolt hex nuts. Always return wrench to storage location after use.

1. With planter raised and cylinder lockups in place, remove wing lock pins at marker support and hitch.

NOTE: If wing lift tires are not raised, with cylinder lockups in place on four center section lift cylinders, move tractor hydraulic control to lowering position until cylinders are fully retracted and wing tires are fully raised.



Wing lock pin locations

NOTE: Hydraulic pressure will prevent selector valve from moving. Release hydraulic pressure from system before attempting to move selector valve handle.

2. Move selector valve to "FOLD".
3. Move the tractor hydraulic control and fold the wings out to operating position.



Selector valve

4. Swing wing lock eyebolts into position to lock each wing.
5. Operate the hydraulic lever to extend the lift cylinders.
6. Remove four center section cylinder lockups from cylinders and place them in storage positions.
7. Lower planter. Hold tractor hydraulic control 5 to 10 seconds with cylinders fully retracted to rephase system.
8. Tighten wing lock 1 1/4" hex nuts.
9. Move selector valve to "MARKER".

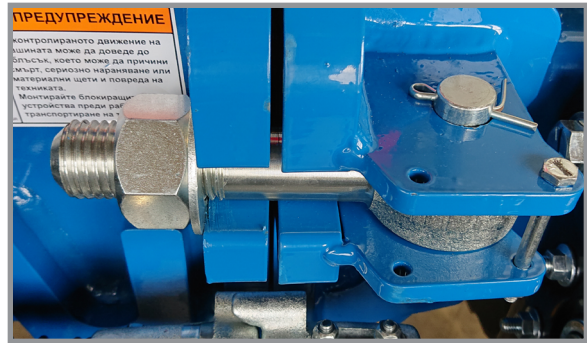

Securing wing lock eyebolt

NOTE: Hydraulic pressure will prevent selector valve from moving. Release hydraulic pressure from system before attempting to move selector valve handle.

HYDRAULIC WING FOLD FIELD OPERATION TO TRANSPORT



WARNING



Planter wings may swing suddenly and cause death or serious injury. Do not stand between wings and frame when folding or unfolding planter. Planter must be on a level surface in all directions.

SUMMARIZED FIELD TO TRANSPORT SEQUENCE

- Raise row markers and lower planter.
- Move selector valve to "FOLD".
- Loosen wing lock eyebolts and swing over to unlock wings.
- Raise planter.
- Install lockups on center lift cylinders.
- Retract wing lift cylinders.
- Hydraulically fold wings forward. Lock wings in place.
- Move selector valve to "MARKER".

NOTE: Read following information for detailed instructions.

NOTE: Use special wrench stored on inside of hitch for center turnbuckle and wing lock eyebolt hex nuts. Always return wrench to storage location after use.

1. Fold row markers to raised transport position and lower planter to ground.

NOTE: Hydraulic pressure will prevent selector valve from moving. Release hydraulic pressure from system before attempting to move selector valve handle.

2. Move selector valve to "FOLD".



Selector valve

3. Loosen wing lock 1 1/4" hex nuts and swing wing lock eyebolts over to release planter wings.
4. Raise planter.
5. Install cylinder lockups on four center section lift cylinders.
6. Place tractor hydraulic control in lowering position and hold until wing cylinders are fully retracted and wing tires are fully raised.



Wing lock eyebolt



WARNING

Uncontrolled wing movement can cause death, serious injury, and damage to property and equipment. Make sure wings are properly locked in place before moving planter.

7. Fold each wing forward into transport position and lock wings in place at marker support and hitch with wing safety pins.

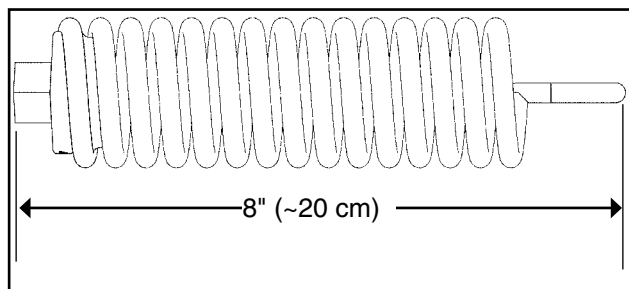
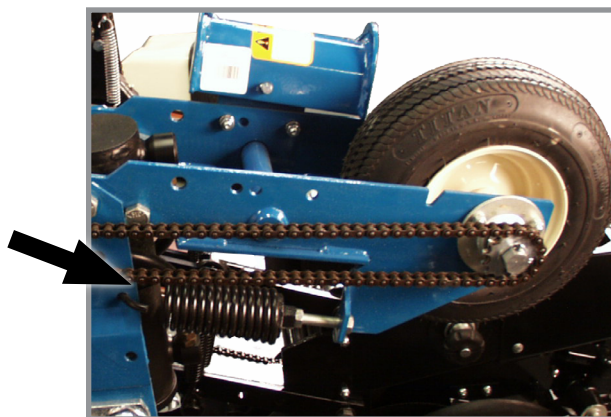

Wing lock pin locations

CONTACT DRIVE SPRING ADJUSTMENT**Spring length measurement (Factory setting)****Down pressure spring location**

There are two down pressure springs on each contact drive wheel. Spring tension is factory preset and normally requires no adjustment.

Basic setting for spring tension is approximately 200 lb (~90 kg) of down force at tire contact point.

NOTE: Measurement must be taken in planting position with proper tire pressure.

SEED RATE TRANSMISSION ADJUSTMENT

Seed rate transmissions allow simple, rapid changes of sprockets to obtain desired planting population. By removing lynch pins on hexagon shafts, sprockets can be interchanged with those from the sprocket storage rod bolted to the transmission.

Chain tension is controlled by a spring-loaded dual-sprocket idler. The idler assembly is equipped with an easy-release idler arm to remove spring tension for replacing sprockets.

Planting rate charts in the Seed Meter Operation section will aid you in selecting correct sprocket combinations.

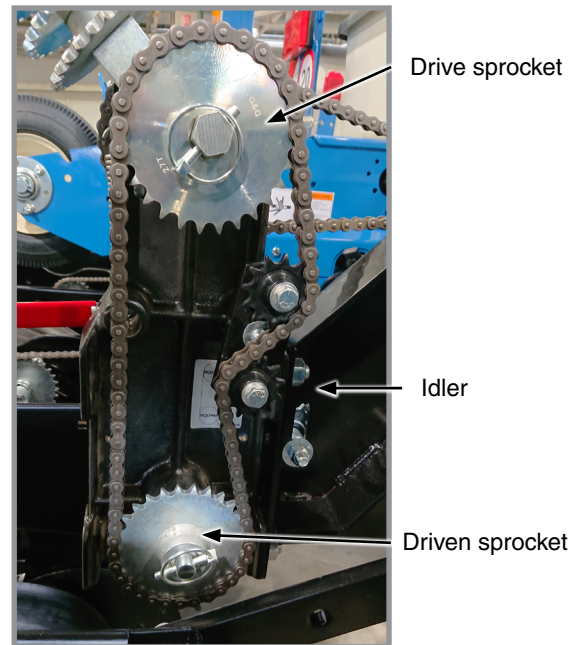

Seed rate transmission chain tension

STANDARD AND HALF RATE (2 TO 1) DRIVES

Seed planting rate charts are based on the standard rate drive using a 17 tooth sprocket unless otherwise specified.

NOTE: Half rate (2 to 1) drive is recommended only when desired population falls below that on planting rate charts.

Replacing the standard 17 tooth drive sprocket located on the inner side of the top transmission shaft, with the 34 tooth half rate (2 to 1) drive reduction sprocket reduces planter transmission speed and planting and application rates by approximately 50%.

NOTE: Do a field check after each sprocket combination adjustment to make sure you are planting at the desired rate.

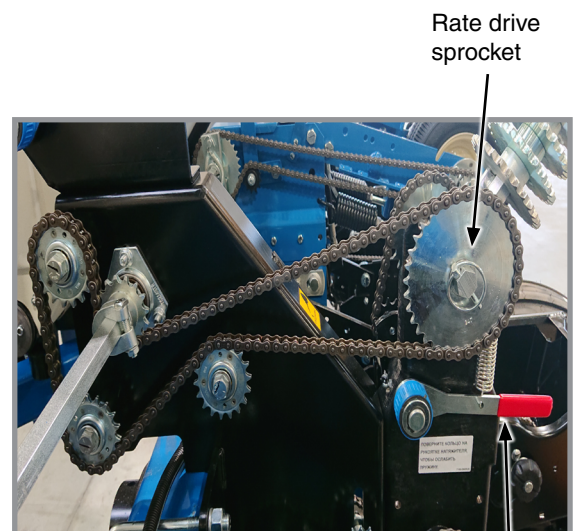

New style transmission

Tension release arm

SHEAR PROTECTION

Shear pins protect the planter driveline and row unit components from damage.

1. Determine where binding has occurred before replacing a pin. Turn shaft by hand (with the aid of a wrench) and check for misalignment and seized parts.
2. When shaft can be turned by hand (with the aid of a wrench) replace shear pins with same size and type. Spare shear pins are in wheel module storage area.

NOTICE

Misaligned drill shaft/transmission coupler can cause equipment damage.

3. Check driveline alignment and follow prescribed lubrication schedules to prevent component binding or breakage.

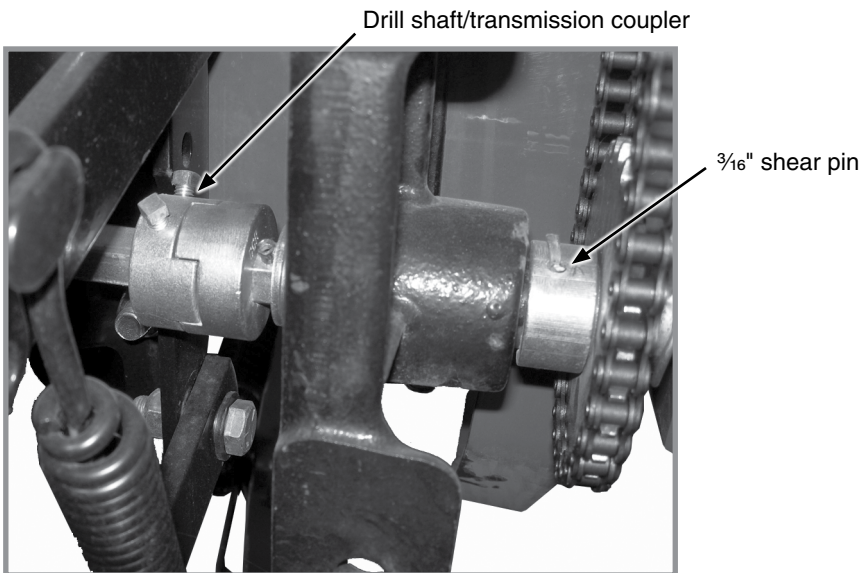

Transmission shaft and drill shaft coupler

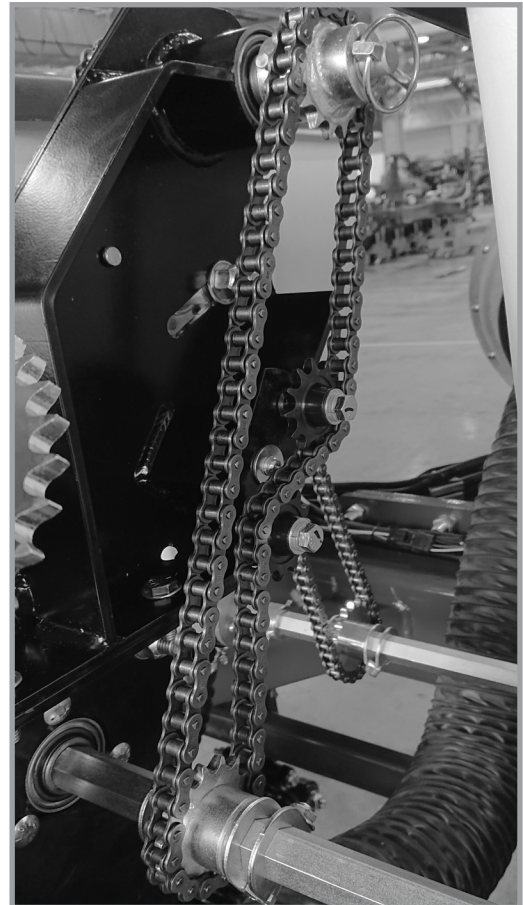

Dry fertilizer driveline

WRAP SPRING WRENCH

Chain idlers use wrap spring wrenches to release and adjust transmission chain tension.

Rotate wrap spring wrench knurled collar while rotating chain idler away from chain to release chain tension.

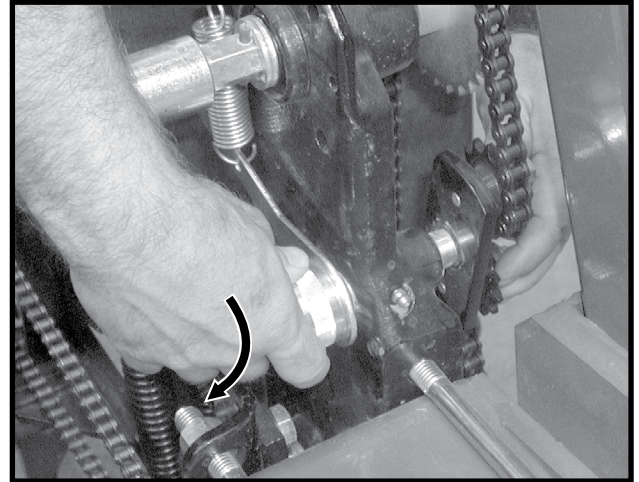

Release chain tension

Rotate chain idler into chain while rotating handle to tension idler spring.

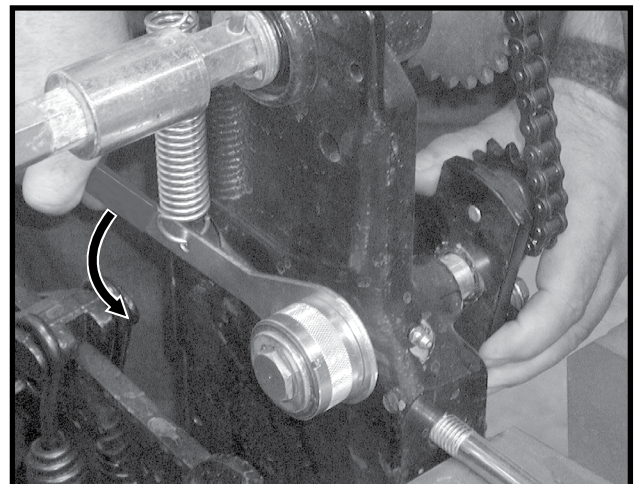

Increase chain tension

TIRE SCRAPER

A tire scraper prevents buildup of dirt and mud between wheel arm assembly and tire.

Adjust scraper so it does not contact tire.

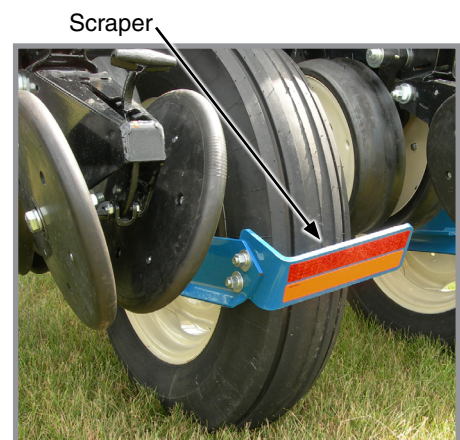

Tire scraper

HYDRAULIC ROW MARKER OPERATION

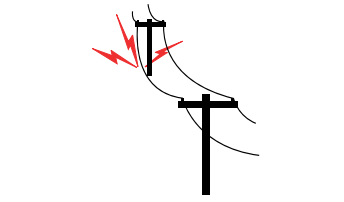
	<p>Contacting or coming close to power lines or other high energy sources will cause death or serious injury.</p>
	<p>Keep away from power lines or high energy sources at all times.</p>

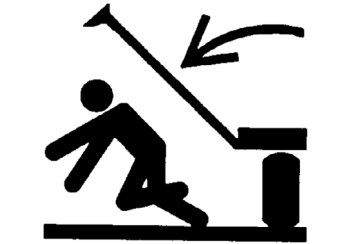
	<p>Row marker can lower at any time and could cause death or serious injury. Stay away from row markers! Install safety lockup device when not in use.</p>
	

All Model 3030 planters are equipped with a dual valve hydraulic system to control row markers. A dual valve hydraulic system allows planter to be raised and lowered without operating row markers. Row markers are controlled on alternating sides through a tractor SCV. The sequencing valve directs flow to marker on opposite side each time a row marker is raised. When lower row marker is selected, row marker on opposite side of row marker last raised is lowered. When raising planter for a waterway the row marker stays down, clears the ground, does not disturb the waterway, and continues to mark when planter is lowered.

Both row markers can be down at the same time. Lower planter and row marker. Move marker control to raise and immediately return it to lower. This shifts the row marker control valve and lowers remaining row marker.

NOTE: A hand operated selector valve selects row marker or wing fold functions on all Model 3030 planters. Remove pressure from hydraulic system before attempting to move selector handle.

ROW MARKER SPEED ADJUSTMENT**NOTICE**

Excessive row marker travel speed can damage row markers. Adjust flow controls before row markers are first used.

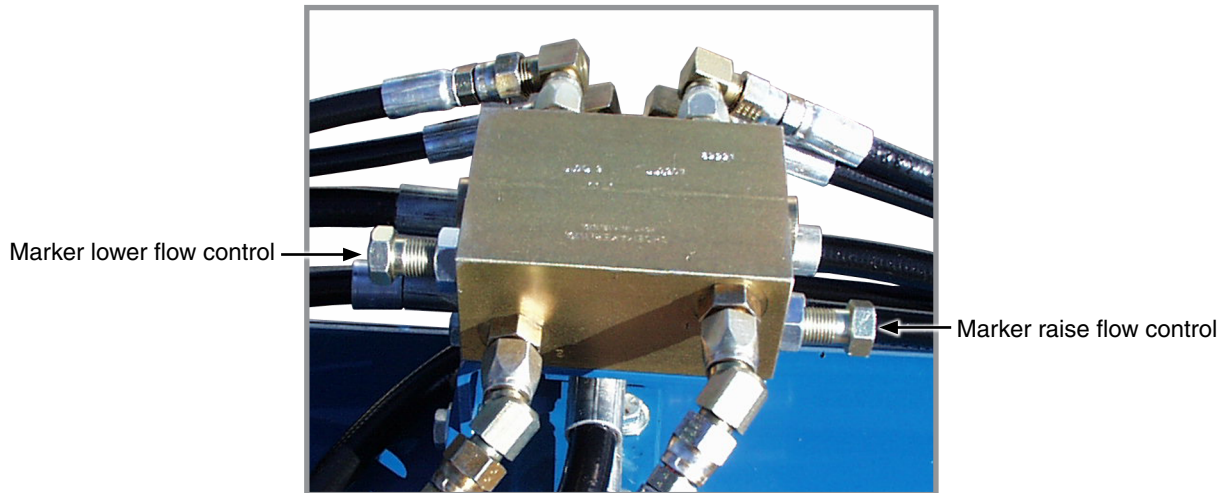

Row marker flow control valves

Two flow control valves determine the amount of oil flow restriction controlling row marker travel speeds. One flow control valve controls lowering speed and one controls raising speed of both markers.

NOTE 1: Hydraulics operate slowly when oil is cold. Make all adjustments with oil warm.

NOTE 2: On a tractor where oil flow cannot be controlled, tractor flow rate may be greater than rate marker cylinder can accept. Hold tractor hydraulic control lever until cylinder reaches end of its stroke. This occurs most often on tractors with an open center hydraulic system.

NOTE 3: On tractors with a closed center hydraulic system, set hydraulic flow control so detent functions properly.

1. Loosen jam nut and turn control clockwise (IN) to slow speed or counterclockwise (OUT) to increase speed.
2. Tighten jam nut after adjustments are made.

ROW MARKER ADJUSTMENTS

1. Multiply number of rows by the average row spacing in centimeters to determine total planting width.

Row Marker Lengths	
8 Row 70 cm	5,60 m

2. Lower planter and row marker assembly to ground.
3. Measure from planter center line to a point where blade contacts ground.
4. Adjust row marker extension so distance from marker disc blade to center line of planter is equal to total planting width. Adjust right and left row marker assemblies equally and securely tighten clamping bolts.

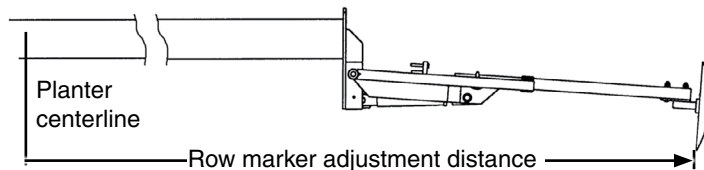

NOTICE

Setting marker disc blade assembly at a sharper angle than needed adds stress to row marker assembly and shortens bearing and blade life. Set blade angle only as needed to leave a clear mark.

Marker disc blade is installed with concave side facing inward. Spindle assembly is slotted so hub and blade can be angled to throw more or less dirt.

5. Loosen hardware and move assembly as required.
6. Tighten bolts to specified torque. See "[Torque Values Chart](#)" on page 6-8". Do a field test to ensure markers are properly adjusted.

NOTE: A notched marker blade is available from Kinze through your Kinze Dealer for use in more severe no till conditions.

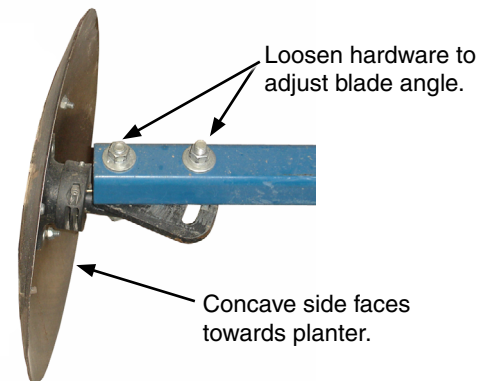

Row marker disc blade angle adjustment

DIGITAL VACUUM READOUT

Digital vacuum readout is incorporated into in-cab display. Refer to the display operation manual for instructions.

VACUUM FAN MOTOR VALVE BLOCK ASSEMBLY

A pressure relief valve in the hydraulic circuit prevents build up of oil pressure over 35 PSI (~241 kPa) in case drain line when vacuum fan motor is operating. This valve will vent oil outside valve block through a drain hole in the aluminum valve block. This can occur whenever case drain is improperly connected or pressure in motor circuit builds.

See "[Hydraulic System Schematic](#)" on page 6-32 in Maintenance section.

Valve block contains a check valve that prevents vacuum fan from operating in wrong direction if pressure is applied to return side of motor and allows fan to coast to a stop when tractor hydraulic control is returned to neutral position.

VACUUM METER SYSTEM

Kinze vacuum meter seed metering system includes seed meters, seed discs, and an air system consisting of a hydraulic driven vacuum fan which draws air through manifolds, hoses, and seed meters on each row unit.

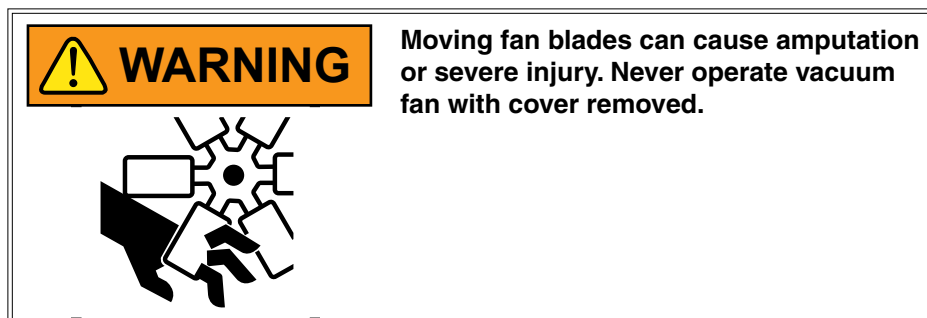

NOTE: If planter is equipped with Vacuum and Seed hopper extensions, SMV sign needs to be relocated, per specific country road homologation requirements.

ANALOG VACUUM OR PRESSURE GAUGE

Analog vacuum or pressure gauge connects directly to vacuum meter (vacuum) or bulk fill (pressure) manifold and is teed into digital sending units.

Only adjustment is to "zero" needle with no vacuum or pressure present. If there is a significant difference between gauge and a reading taken at meters, a different manifold location should be found to connect hose to gauge and digital sending unit.

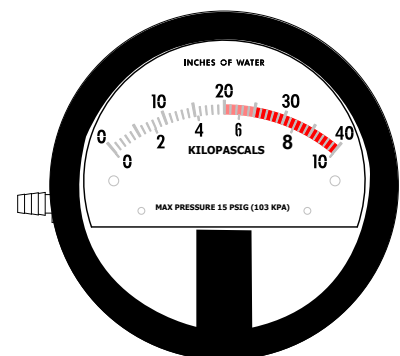

Analog Gauge

NOTE: Analog gauges are identical EXCEPT for plug and hose barb locations in side of gauge housing. DO NOT connect vacuum meter or bulk fill hose to wrong gauge. Check plug and hose barb installation if readout is erratic or appears inaccurate.

RIDGE PLANTING

Planter toolbar height can be raised 3" (~8 cm) for ridge planting.

1. Relocate 20" transport axles to lower rear holes in ground drive wheel arm.

New axle location.

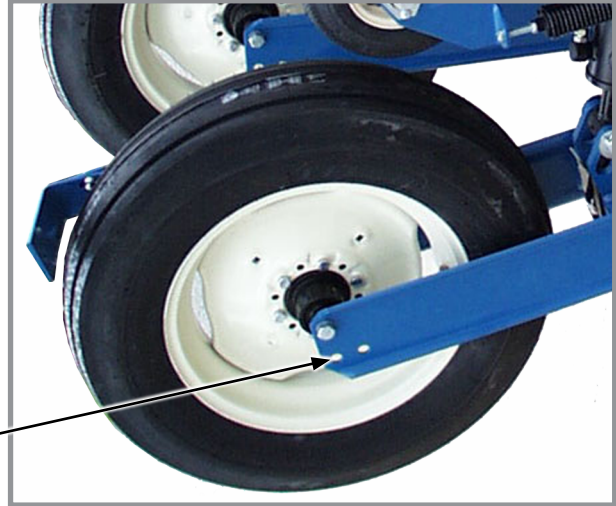

Transport axle

2. Mount contact drive wheel arm and springs to lower set of mounting holes in wheel module mount.
3. Raise hitch height to keep planter level front and rear.

Move contact drive wheel arm here.

Move springs here.

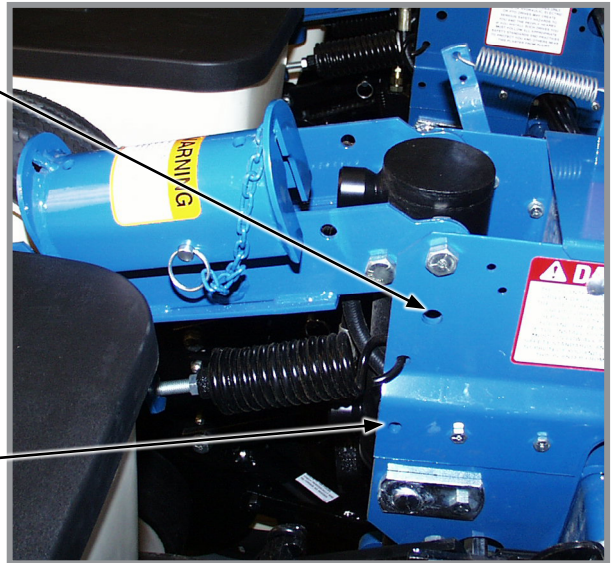

Wheel module mount

PLANTING SPEED

Planters are designed to operate within a speed range of 2 to 8 mph (~3 - 13 km/h). See "[General Planting Rate Information](#)" on page 5-1. Variations in ground speed produce variations in rates. Finger pickup seed meter populations tend to be disproportionately higher at high ground speeds.

NOTE: Seed spacing can be adversely affected at speeds above 5 mph (~8 km/h).

FIELD TEST

Perform a field test with any change of field and/or planting conditions, seed size or planter adjustment to ensure proper seed placement and operation of row units. See ["General Planting Rate Information" on page 5-1](#), ["Check Seed Population" on page 2-25](#), and ["Granular chemical field check" on page 4-5](#).

- Check planter for front to rear and lateral level operation. See ["Level Planter" on page 2-11](#).
- Check **all** row units to be certain they are running level. Row unit parallel arms should be approximately parallel to the ground when planting.
- Check row markers for proper operation and adjustment. See ["Row Marker Adjustments" on page 2-22](#) and ["Row Marker Speed Adjustment" on page 2-21](#).
- Check for proper application rates and placement of granular chemicals on **all** rows. See ["Granular chemical field check" on page 4-5](#).
- Check for desired depth placement and seed population on **all** rows. See ["Check Seed Population" on page 2-25](#).
- Check for proper application rates of fertilizer on **all** rows. See proper "Fertilizer Application Rate Chart" (["Rate Charts" on page 5-1](#)).

Reinspect machine after field testing.

- Hoses And Fittings
- Bolts And Nuts
- Cotter Pins And Spring Pins
- Drive Chain Alignment

CHECK SEED POPULATION

1. Tie up one or more sets of closing wheels by running a chain or rubber tarp strap between the hopper support panel and closing wheels. It may be necessary to decrease closing wheel arm spring tension.

Chain, rubber tarp strap, or similar.

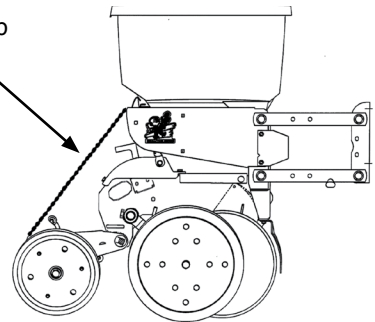

2. Plant a short distance and check to see if seed is visible in the seed trench. Adjust planting depth to a shallower setting if seed is not visible and recheck.

Planting depth adjustment handle

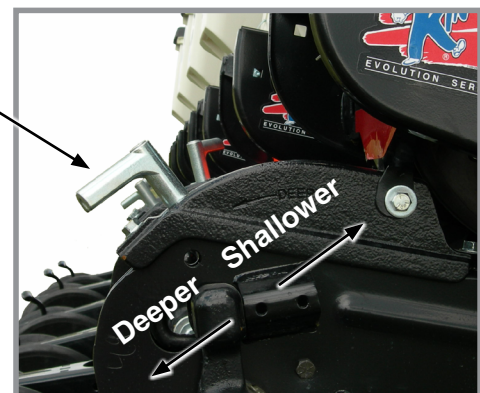

Planting depth adjustment

3. Measure $\frac{1}{1000}$ of a hectare. See chart for correct distance for row width being planted.

$\frac{1}{1000}$ Hectare Seed Population Count Row Width/Distance	
Row Width	70 cm
Distance	14,28 m

NOTE: Seeds may bounce or roll when planting with closing wheels raised and planting depth set shallow affecting seed spacing accuracy.

4. Count seeds in measured distance.
5. Multiply number of seeds placed in $\frac{1}{1000}$ of a hectare by 1000. This gives total population.

EXAMPLE: 70 cm row spacing 14,28 m equals $\frac{1}{1000}$ hectare.

75 seeds counted x 1000 = 75000 seeds per hectare

Seed count can be affected by drive wheel and seed meter drive ratio, tire pressure, and/or seed meter malfunction.

1. If seed check shows average distance between seeds in inches is significantly different than seed rate chart indicates, first check drive ratio between drive wheel and seed meter. Check drive wheel air pressure, check for incorrect sprocket(s) in driveline and check drive and driven sprockets on transmission(s) for proper selection.
2. Check for seed meter malfunction. For example, if spacing between kernels of corn at the transmission setting being used is 8" (~20 cm) and a gap of 16" (~40 cm) is observed, a finger has lost its seed and not functioned properly. If two seeds are found within a short distance of each other, the finger has metered two seeds instead of one.
3. See ["Seed Meter \(Finger Pickup\) Troubleshooting" on page 7-5](#) and/or ["Seed Meter \(Brush-Type\) Troubleshooting" on page 7-4](#) in the Troubleshooting Section of this manual.

DETERMINING KILOGRAMS PER HECTARE (BRUSH-TYPE METER)

Seeds per hectare ÷ Seeds per kilogram (from label) = Kilograms per hectare

If seeds per kilogram information is not available use the following averages:

5720 seeds per kilogram for medium size soybeans

33000 seeds per kilogram for medium size milo/grain sorghum

9900 seeds per kilogram for medium size cotton

PLANTING DEPTH

Planting depth is maintained by adjustable row unit gauge wheels. Depth adjustment range is approximately ½" to 3½" (~1 to 9 cm).

1. Raise planter to remove weight from wheels.
2. Push down on depth adjustment handle and reposition it forward to decrease or rearward to increase planting depth. Initially adjust all units to the same setting.
3. Lower planter and check operation and planting depth of all row units. Readjust individual rows as needed for uniform operation.

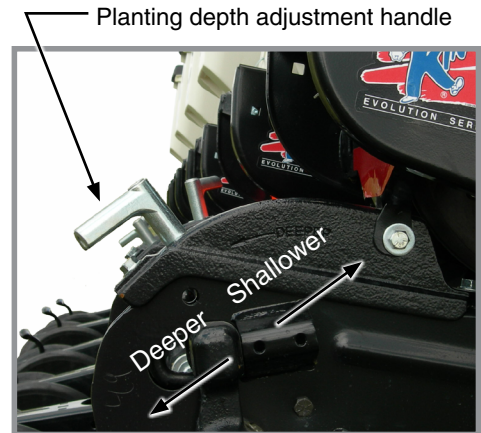

Planting depth adjustment

“V” CLOSING WHEEL ADJUSTMENT (RUBBER OR CAST IRON)

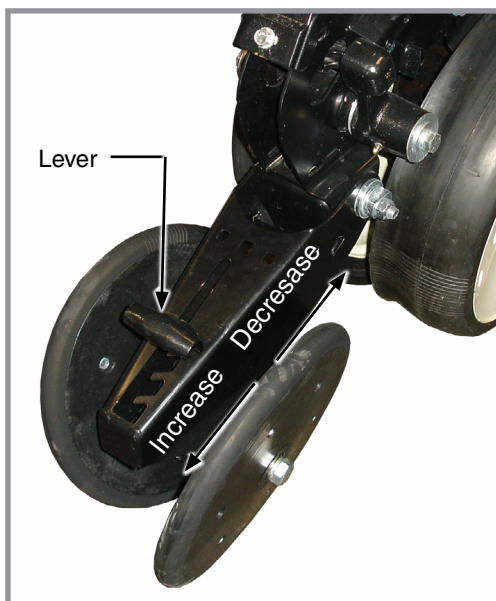

“V” Closing wheels installed offset

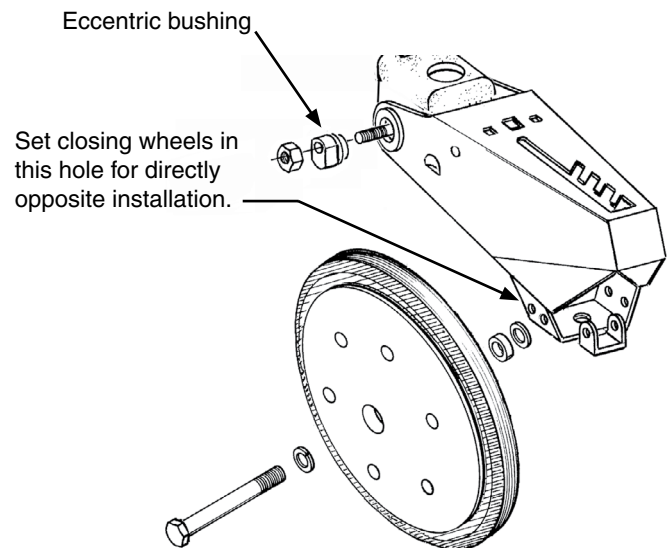

“V” closing wheels should have enough down pressure to close the seed trench and ensure good soil to seed contact. Move 5-position quick adjustable down force lever on the top of closing wheel arm to the rear to increase closing wheel spring pressure. Move lever forward to decrease pressure. Adjust all row units to a similar setting. Light soil usually requires less down force at average depth (approximately 2" (~5 cm)) while heavy soil requires increased down force.

Eccentric bushings in the wheel arm stop allow for lateral adjustment of the “V” closing wheel assembly. Use a ¾" wrench to loosen hardware attaching closing wheel arm to wheel arm stop. Use another ¾" wrench to turn eccentric bushings until **closing wheels are aligned with seed trench**. Tighten hardware.

Closing wheels can be installed “offset” (to improve residue flow) or “directly” opposite. Use forward installation holes if set “directly” opposite.





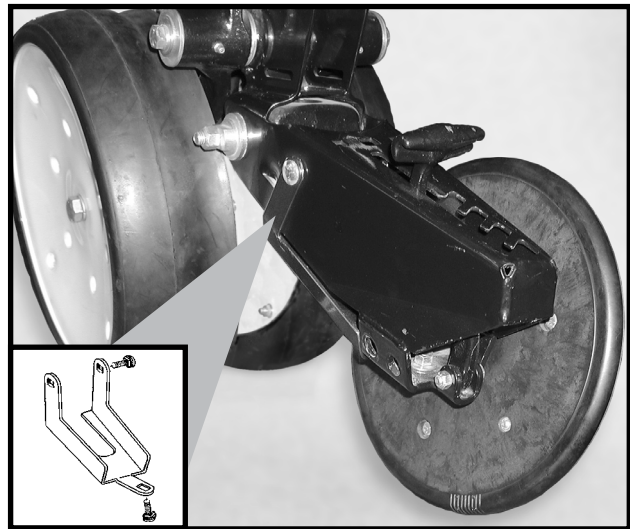





CLOSING WHEEL SHIELD (RUBBER OR CAST IRON "V" CLOSING WHEELS)

Optional closing wheel shield is installed on underside of closing wheel arm to help prevent root balls and stalks from clogging closing wheels.



**Closing wheel shield
(Shown with closing wheel removed)**

BRUSH-TYPE SEED METER

	Crop	Disc Color-Code (Disc Part No.)	Upper Brush Retainer	Cells	Seed Size Range	*Lubricant
	Soybean	Black (GA5794)	GD11122	60	4840 to 8800 seeds/kg	Graphite Talc
	Specialty Soybean	Dark Blue (GA6184)	GD11122	48	3080 to 4840 seeds/kg	Graphite Talc
	Small Milo/Grain Sorghum	Red (GA5982)	GD8237	30	30800 to 44000 seeds/kg	Talc
	Large Milo Grain Sorghum	Light Blue (GA6187)	GD8237	30	22000 to 35200 seeds/kg	Talc
	High-Rate Small Milo/Grain Sorghum	Red (GA5795)	GD8237	60	26400 to 39600 seeds/kg	Talc
	High-Rate Large Milo/Grain Sorghum	Yellow (GA6633)	GD8237	60	22000 to 30800 seeds/kg	Talc
	Cotton, Acid-Delinted	White (GA5796)	GD11122	30	9240 to 11440 seeds/kg	Talc
	Large Cotton, Acid Delinted	Tan (GA6168)	GD11122	36	8360 to 9680 seeds/kg	Talc
	High-Rate Cotton, Acid-Delinted	Light Green (GA6478)	GD11122	48	9240 to 11440 seeds/kg	Talc
	Hill-Drop Cotton, Acid-Delinted	Brown (GA6182)	GD11122	12 (3 to 6 seeds/ cell)	8800 to 11400 seeds/kg	Talc
	Small Hill-Drop Cotton, Acid-Delinted	Dark Green (GA7255)	GD11122	12 (3 to 6 seeds/ cell)	11000 to 13640 seeds/kg	Talc

*For More information on application rate see ["Additives"](#) on page 3-8.

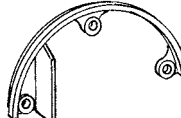
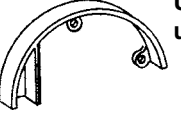
	<p>Use GD11122 upper brush retainer when using cotton and soybean discs.</p>		<p>Use GD8237 upper brush retainer when using milo/grain sorghum discs.</p>
---	---	--	--

Turn seed disc counterclockwise when installing on meter hub while tightening two wing nuts that retain disc. Seed disc should have slight resistance when rotated counterclockwise after wing nuts are tight.

Brush-type seed meter attaches to seed hopper same as finger pickup seed meter. Secure to bottom of seed hopper with two 5/16" thumbscrews. Tighten thumbscrews slightly with pliers. **DO NOT OVER TIGHTEN.**

Misalignment between drive coupler and seed meter input shaft may cause erratic seed spacing from momentary stoppage of seed disc. Check alignment and adjust as needed.

Refer to planting rate charts in this manual for recommended seed drive transmission sprocket combinations.





Shown without seed disc installed

NOTE: Clean seed is required to ensure accurate seed metering from brush-type seed meters. Remove seed discs daily and check seed meter or brushes for buildup of foreign material, such as hulls, stems, etc.

NOTICE	Replace hopper lids after hoppers are filled to prevent accumulation of dust or dirt in seed meter which will cause premature wear.
---------------	--

FINGER PICKUP SEED METER

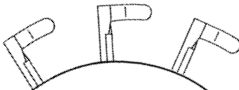
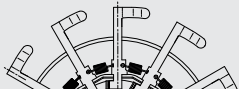











Crop	Fingers	*Lubricant
Corn	 Part No.: GR1848 - Finger Assembly, Corn	Graphite Talc
No. 1 and/or No. 2 size Confectionery Sunflower Seeds	 Part No.: GR1848 - Finger Assembly, Corn	Talc
No. 3 and/or No. 4 size Oil Sunflower Seeds	 Part No.: GR2154 - Finger Assembly, Oil	Talc
Blank fingers replace alternate fingers to reduce planting rate by half while allowing the finger wheel to maintain a minimum of 40 RPM when planting low rates.	 Part No.: GD11787 - Half Rate Blank Finger	Graphite Talc

*For More information on application rate see ["Additives"](#) on page 3-8

NOTE: Always field check seed population to verify planting rates.

NOTE: Refer to planting rate charts (["General Planting Rate Information"](#) on page 5-1) for recommended seed drive transmission sprocket combinations.

VACUUM SETTINGS

Crop		**Seed Disc Kit	Seed Disc Part No.	Ejector Wheel (Color)	Cells	Seed Size Range	Singulator Zone Setting	Vacuum Setting Inches of Water (cm)	Lubricant
	Corn ‡ Large Sweet Corn	G10276X	B1219 (Light Blue)	1 row 5 punches (Light Blue)	40	2500-5000 seeds/kg	2	18-20 (46-51)	Graphite* Talc*
	Soybean	G10277X	B1232 (Black)	2 rows 6 punches (Black)	120	4850-8820 seeds/kg	0	10-14 (25-36)	Graphite* Talc*
	Sugar Beet	G10279X	B1229 (Dark Orange)	1 row 6 punches (Dark Orange)	60	Pelletized	2	15 (38)	Graphite*
	Milo	G10279X	B1229 (Dark Orange)	1 row 6 punches (Dark Orange)	60	22000-44000 seeds/kg	2	15 (38)	Graphite* Talc*
	Sunflower ‡ Small Sweet Corn	G10278X	B1230 (Gray)	1 row 5 punches (Gray)	40	Oil seeds #2, 3, 4	2	12-18 (30-46)	Graphite* Talc*
	Sunflower	G10278X	B1230 (Gray)	1 row 5 punches (Gray)	40	Oil seeds #5	2	5-8 (13-20)	Graphite* Talc*
	Specialty Disc 1	G10280X	BB1233 (Green)	1 row 6 punches (Green)	60	Cotton	2	15-20 (38-51)	Graphite* Talc as needed*
	Specialty Disc 2	G10281X	B1235 (Brown)	1 row 6 punches (Green)	60	Black turtle & navy edible beans	2	15-20 (38-51)	Graphite* Talc as needed*
	Specialty Disc 3	G10282X	B1234 (Dark Blue)	1 row 6 punches (Green)	60	Pinto & Great Northern edible beans & low-rate soybean	2	15-20 (38-51)	Graphite* Talc as needed*
	Wheat disc	G10274X	GB1236 (Purple)	Brush type	54	N/A Volumetric	0	6-16 (15-41)	Graphite* Talc*

Install selected seed disc. Position vacuum cover on meter by aligning keyhole slots over bolt heads. Push cover on meter and turn counter clockwise to lock in place.

NOTE: See ["Check Seed Population" on page 2-25](#) for more information. Always field check seed population to ensure planting rates are correct.

NOTE: Singulator settings are marked from 0 - 3.

NOTE: Mixing seed sizes and shapes affects meter performance. Use consistent seed size and shape.

NOTE: Use 1 tablespoon powdered graphite with standard each hopper fill of seed. Seed treatment, foreign material, dirt or seed chaff may cause gradual reduction of seed disc fill (population). See ["Additives" on page 3-8](#) for more information.

NOTE: Excessive seed treatment, humidity, and light-weight seed can affect meter performance. Use ½ cup of talc with each standard hopper fill of seed and mix thoroughly to coat all seeds and adjust rates as needed. Use of talc aids seed flow into meter, singulation, and disc seed drop.

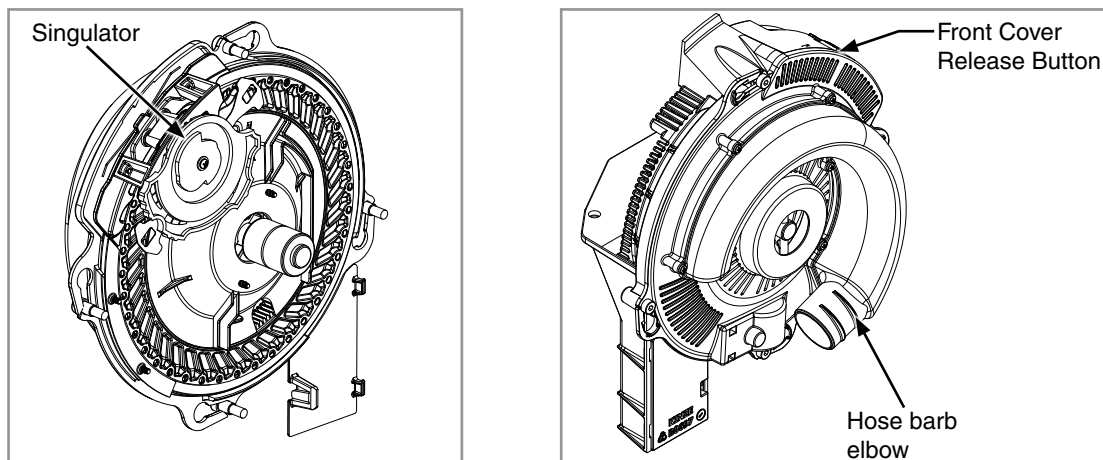

NOTE: Foreign material in seed disc orifices, such as seed chips, hulls, stems, etc., may affect seed delivery. Clean seed ensures accurate seed metering from vacuum seed meter. Remove Seed discs daily to check for buildup of foreign material in seed disc orifices.

Air inlet screens allow air to enter system and aids in keeping field residue or other foreign material out of meter.

See ["Vacuum Seed Meter Maintenance" on page 6-16](#) and ["Preparing Planter for Storage" on page 6-28](#) in Lubrication and Maintenance section for more information.

NOTE: Damaged seed or seed containing foreign material will cause plugging of seed disc orifices and require more frequent seed meter cleanout to prevent underplanting.

Wheel-Type Ejectors

Wheel-type ejectors expel seed remnants from seed disc orifices. These ejectors are disc specific and colored coded to match disc.

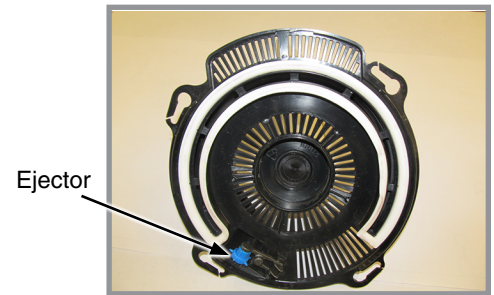

NOTICE

Replace hopper or tank lids after filling to prevent accumulation of dust or dirt in seed meter resulting in premature wear.

NOTE: Seed size, seed shape, seed treatments, travel speed, and planting rate affect meter performance.

1. Select seed disc and ejector to match crop and population.

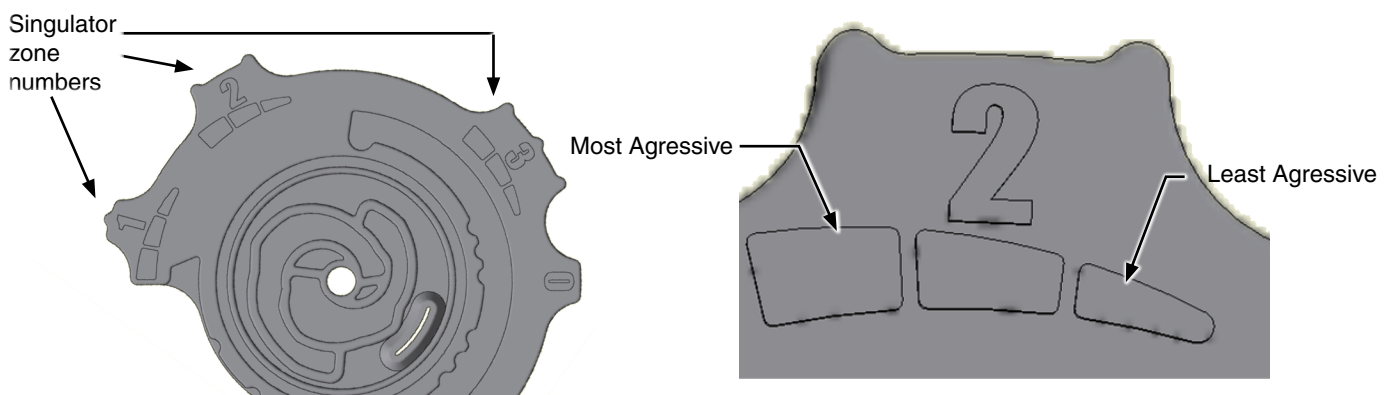

Singulator Adjustment Wheel

2. Adjust singulator wheel to initial setting. Seed size, seed shape, seed treatments, travel speed and planting rate all affect meter performance.
3. With vacuum fan running, lower planter to planting position and drive forward a short distance to load seed into seed disc cells.
4. Adjust vacuum level to initial setting according to tables on page.

NOTE: Vacuum reading will be much lower when seed disc cells are empty. Load all seed cells before setting vacuum level.

NOTE: Operate vacuum fan 3-5 minutes to bring oil up to normal operating temperature prior to making final vacuum level adjustment.

ADDITIVES

The use of graphite is recommended to promote seed flow, provide lubrication for the seed meter and to help dissipate static charge buildup. Among the available dry seed lubricants graphite is the most effective and easiest to use and it requires no mechanical agitation

CONVENTIONAL HOPPERS

Mix one tablespoon of **powdered graphite** with seed each time hoppers are filled. Regular graphite use prolongs life of the seed meter components, improves seed spacing, and may reduce buildup of seed treatments.

NOTE: DO NOT apply graphite only in center of hopper. It will filter too quickly through the seed and not distribute as evenly as desired.

Apply graphite around outer perimeter of hopper.

BULK FILL HOPPERS

Mix 450 g (1 lbs) bottle of powdered graphite each time the bulk seed hopper is filled. Graphite should be added in layers as the bulk seed hoppers are filled. Regular graphite use prolongs life of the seed meter components, improves seed spacing, and may reduce buildup of seed treatments.

Lubricant Application Rate	
Graphite	
Conventional Hoppers	15 ml/Hopper Fill
Bulk Fill Hoppers	450 g (1 lbs.) Bottle/Hopper
Talc	
Conventional Hoppers	60 ml (¼ Cup)*
Bulk Fill Hoppers	1,8 kg (4 lbs)/Hopper*
*Double amount of talc for sunflowers.	



Adding graphite to conventional hopper



Adding graphite bulk fill hopper

NOTE: Additional graphite may be required to retard buildup of seed treatments on meter components. More frequent cleaning of monitor seed tubes may be necessary due to use of additional graphite.

Talc seed lubricant may be used as a drying agent in addition to graphite lubrication. The drying agent may improve seed release and/or **to retard buildup of seed treatments on meter components.**

1. Fill hopper $\frac{1}{2}$ full of seed, add 60 ml ($\frac{1}{4}$ cup) (conventional); 900 g (2 lbs) (Bulk Fill) of talc and **mix thoroughly.**
2. Finish filling hopper, add another 60 ml ($\frac{1}{4}$ cup) (conventional); 900 g (2 lbs) (Bulk Fill) of talc and **mix thoroughly.**
3. Adjust rate of talc use as needed so all seeds are coated, while avoiding a buildup of talc in bottom of hopper.

Humid conditions and/or small sized seeds with extra seed treatment may require additional talc to maintain meter performance.

NOTE: Liquid seed treatments or inoculants may create buildup on the seed disc or brushes. Check frequently for proper population and/or seed delivery when using any liquid seed treatment.

Completely mix all treatments with seed following manufacturers' recommendations. Seed treatment dumped on top of seed after hopper is filled may not mix properly and cause seed bridging, reducing population or stopping meter from planting.

SEED HOPPER

Mechanical seed hopper has a capacity of 1.9 bushels (~67 l).

Vacuum seed hopper has a capacity of 1.75 bushels (~62 l).

Use clean seed and make certain there are no foreign objects inside when filling seed hopper. **Replace hopper lids after hoppers are filled to prevent accumulation of dust or dirt in seed meter which can cause premature wear.** See "Finger Pickup Seed Meter" and/or "Brush-Type Seed Meter".

Periodically empty hoppers completely to remove any foreign objects and to ensure proper seed meter operation.

Disengage meter drive and hopper latch and lift hopper off hopper support. See section "Seed Meter Drive Release" below.



Seed hopper

SEED METER DRIVE RELEASE

A clutch release mechanism disengages seed meter drive from seed meter to remove seed hopper. Disconnecting drive allows operator to check granular chemical application rates without dropping seed. It also allows one or more rows to be disconnected when finishing fields.

Turn knob ¼ turn counterclockwise to disengage or ¼ turn clockwise to engage.

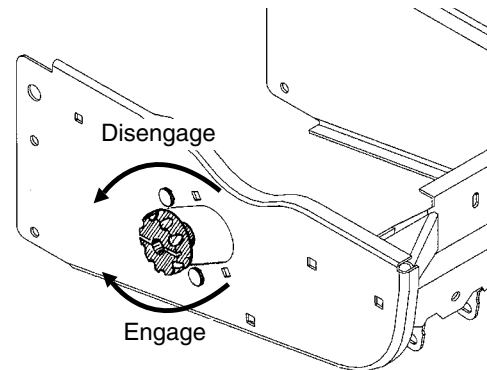

Seed meter drive release

ROW UNIT EXTENSION BRACKETS

Row unit extension brackets extend row units rearward 4" (~10 cm) to provide clearance for coulter mounted residue wheels and HD single disc fertilizer openers at the same time.

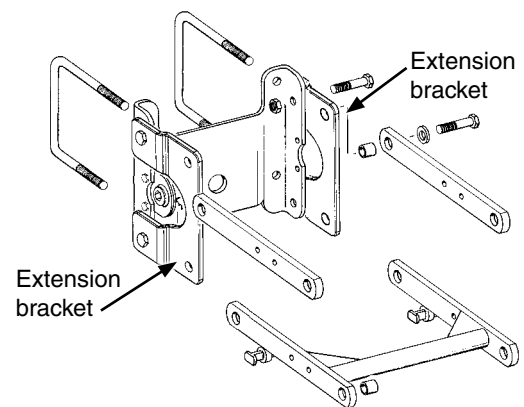

Row unit extension brackets

ROW UNIT CHAIN ROUTING

Row unit drive chains must be properly tensioned and aligned for proper operation and to minimize wear.

Inspect and replace weak, worn or broken springs, idlers, and idler bushings.

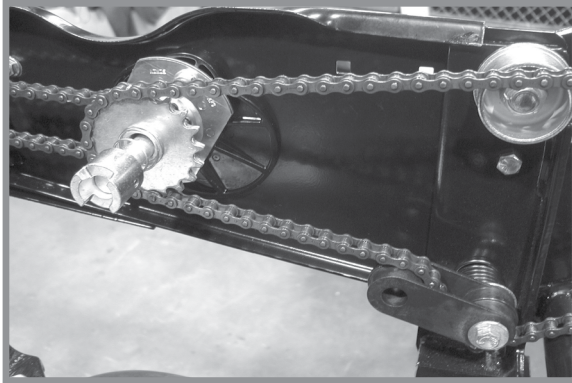

Mechanical pull row unit meter drive

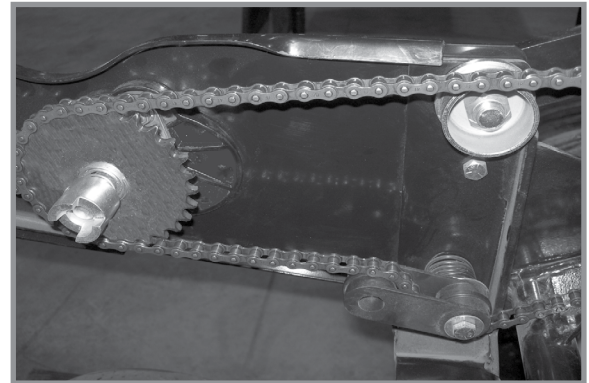

Vacuum pull row unit meter drive

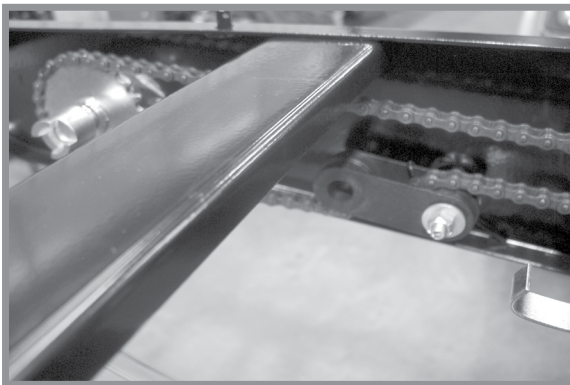

Row unit granular chemical drive

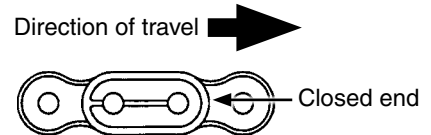

NOTE: Install connector link with closed end facing direction of travel.

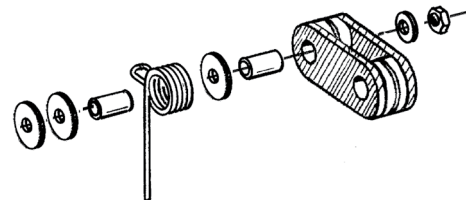

NOTE: Reverse idler when worn on one side for extended use.

QUICK ADJUSTABLE DOWN FORCE SPRINGS OPTION

Quick adjustable down force springs increase penetration in hard soil and keep row unit from bouncing in rough field conditions. Two springs per row, one on each side parallel arms, are used unless equipped with row unit mounted no till coulters. Four springs per row are used with row unit mounted no till coulters.

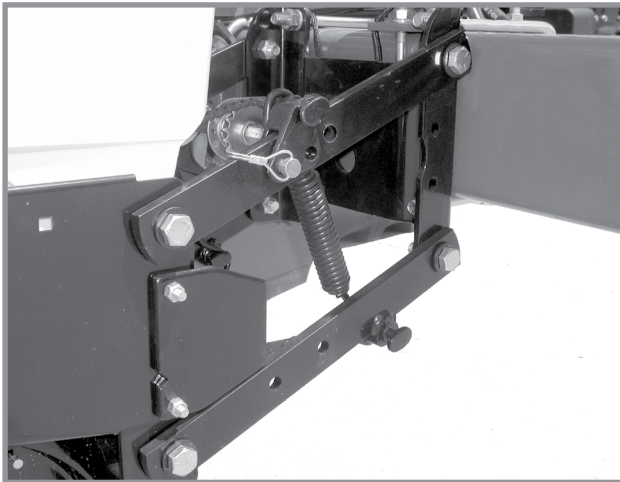

Two Springs Per Row (Dual)

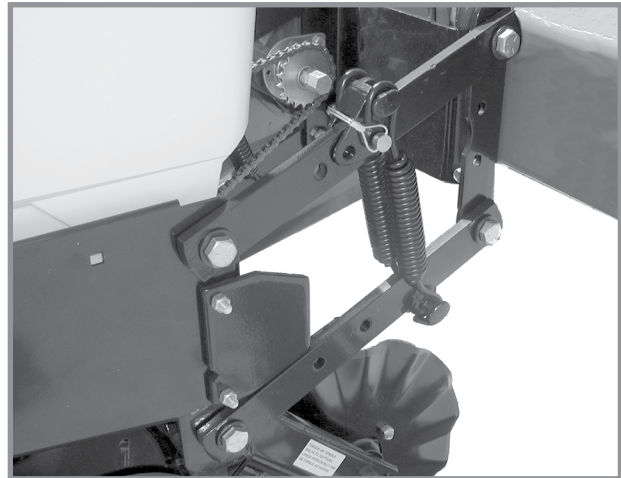

**Four Springs Per Row (Quad)
(Row Unit Mounted No Till Coulters Only)**

There are four positions for spring tension adjustment. Position 1 sets minimum down pressure and position 4 sets maximum down pressure.

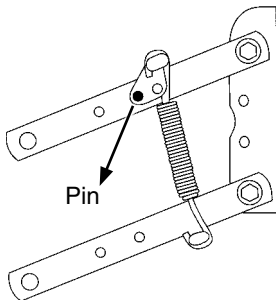

Position 1 (Least)

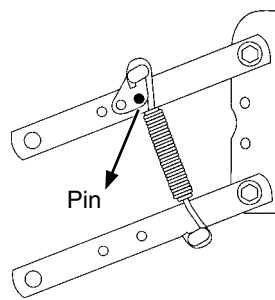

Position 2

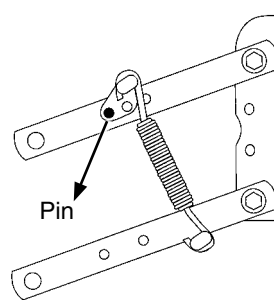

Position 3

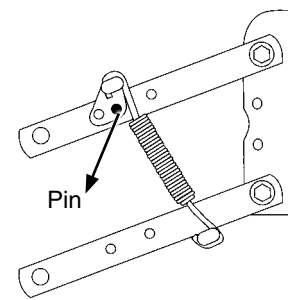

Position 4 (Most)

NOTICE

Springs must be installed with open side of spring hooks toward seed hoppers to prevent binding on spring mount adjustment pins.

1. Raise planter and remove spring mount pin at top of spring.
2. Slide mount to desired position and install pin.

NOTE: Adjust springs for field conditions. Too much down pressure in hard field conditions can cause row units to lift planter and keep drive wheels from making contact. Too much down pressure in soft field conditions can cause row unit to run too deep.

FRAME MOUNTED COULTER

Frame mounted coulters with 1" (~2,5 cm) bubbled, 1" (~2,5 cm) fluted (8 flutes) or ¾" (~2 cm) fluted (~13 flutes) blades are used on pull row units only.

Springs provide down pressure on coulters for maximum penetration while exerting less shock load on row unit.

Initial coulters blade location is in top hole. Relocate blade to one of lower two holes (1" (~2,5 cm) increments) as wear occurs or for deeper blade operation.

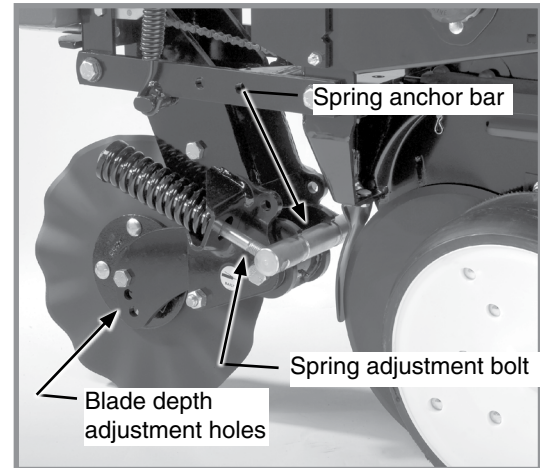

Frame mounted coulter adjustment

DOWN PRESSURE ADJUSTMENT

NOTICE	Excessive down pressure can damage coulters components when coulters strikes an obstacle. Do not set down pressure higher than needed for consistent soil penetration.
---------------	---

Raise planter. Turn spring adjustment bolts clockwise to increase or counterclockwise to decrease down pressure. Set both springs to specification shown in following table:

Frame Mounted Coulter Spring Downpressure Settings		
End flush with spring anchor bar	Extended ½" (~1 cm) through spring anchor bar	All threads used
125 kg	181 kg	227 kg

RESIDUE WHEELS (FOR FRAME MOUNTED COULTER)

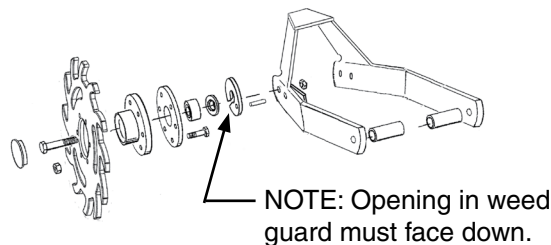

Residue wheels attach to frame mounted coulters with two cap screws and sleeves allowing the unit to free-float. A 2-position spindle bolt mounting positions wheels interlocked or staggered. Depth adjustment is made with a spring-loaded cam and pin with 11 positions in 6 mm increments. A high point on the cam allows wheels to be locked up.

A weed guard on the inboard side of each wheel helps prevent weed wrap which can cause premature bearing failure.

ROW UNIT MOUNTED RESIDUE WHEEL

Row unit mounted residue wheel are used on pull row units.

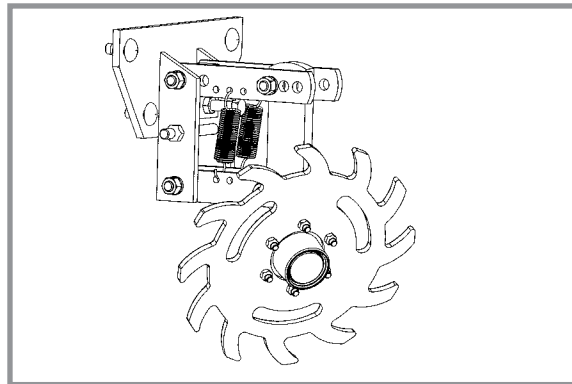

Row Unit Mounted Residue Wheel

Two adjustable springs on each residue wheel parallel links provide down force adjustment. Position 1 provides minimum down pressure and position 3 maximum down pressure.

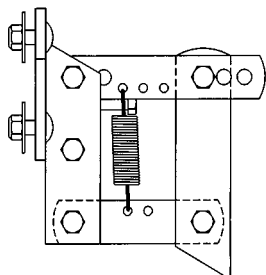

Position 1 (Least)

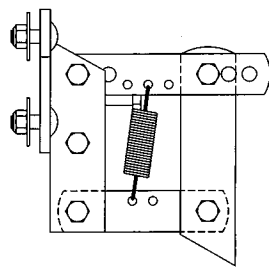

Position 2

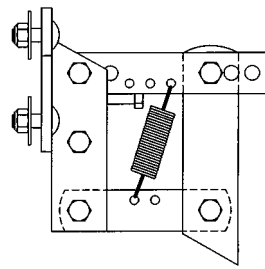

Position 3 (Most)

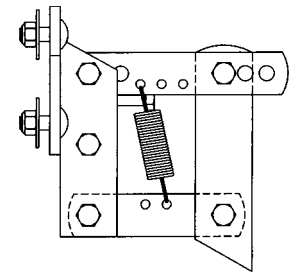

Additional uplift or float

Raise row unit and reposition springs to adjust down pressure.

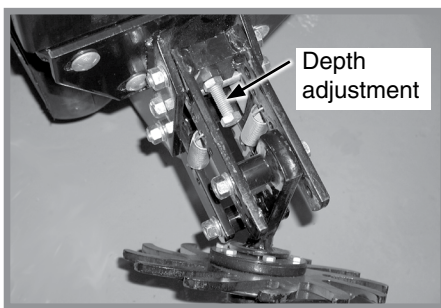

Wheel depth adjustment

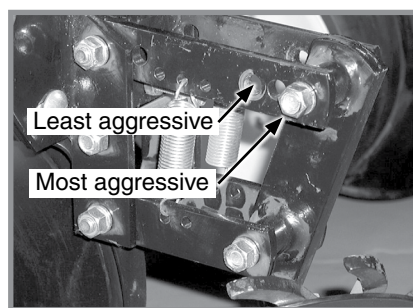

Wheel angle adjustment

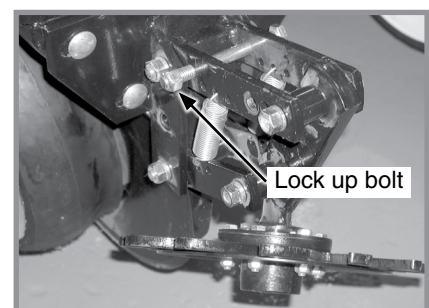

Wheel lock up

A full threaded bolt and jam nut located on the upper link sets maximum depth for loose soil conditions. Initial setting is 1 3/4" (~5 cm) above row unit double disc opener depth.

Three holes in upper link adjust wheel angle. With wheel mount in most vertical position, using the rear hole in the upper link, the residue wheel is most aggressive. Moving wheel mount to a forward hole reduces aggressiveness of residue wheel for use in mulch till applications where soil is loose.

To lock residue wheel up, remove 1/2" x 5" lockup bolt, raise residue wheel and install bolt.

SPIKED CLOSING WHEEL

Spiked closing wheels crumble the sidewall, allowing roots to penetrate soil.

Align spiked closing wheels straight across from each other, in most rearward holes on closing wheel arm. Set the wheels 1" - 1¼" (~2,5 - 3 cm) apart at the closest point. If large amounts of contouring is being done, mount wheels in the forward most hole. This will reduce drifting of row unit.

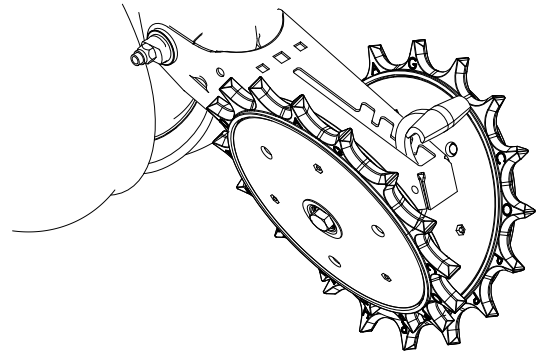

Row Unit Spiked Closing Wheel

ROW UNIT MOUNTED NO TILL COULTER

Row unit mounted no till coulters with 1" (~2,5 mm) bubbled, 1" (~2,5 cm) fluted (8 flutes) or ¾" (~2 cm) fluted (13 flutes) blades may be used on pull row units (¾" fluted shown). Four quick adjustable down force springs are required per row when using row unit mounted no till coulters. See "Quick Adjustable Down Force Springs Options".

Align coulters to row unit double disc openers. Adjust by loosening four attaching bolts, moving coulters, and tightening four attaching bolts. Coulters can be adjusted to one of four ½" (~1 cm) incremental settings in the forked arm. Initial location is the top hole.

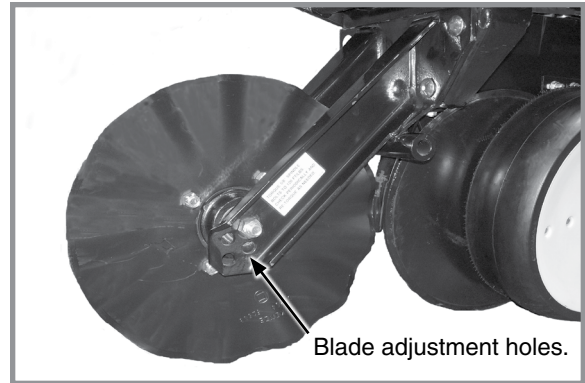

Row Unit Mounted No Till Coulters

Move blade as it wears to one of the three lower holes to maintain coulters at or slightly below opener discs. Adjust coulters below depth of double disc opener blades in very hard soil conditions such as compacted wheel tracks to improve opener penetration and cutting of surface residue.

Check operating depth by setting planter down on a level concrete floor and checking relationship between coulters and row unit opener blade. Make sure planter is level and coulters are square with planter frame and aligned with row unit disc opener.

NOTE: Torque 5/8" spindle hardware to 120 ft-lb (~163 Nm).

COULTER MOUNTED RESIDUE WHEELS

Coulters mounted residue wheels are designed for use on pull row units. Row unit extension brackets are required on the four center pull row units if the planter is equipped with coulters mounted residue wheels.

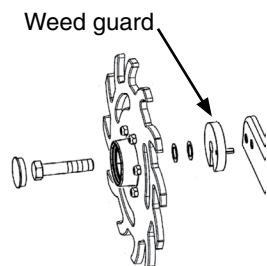

NOTE: Opening in weed guard must face down.





Coulters mounted residue wheels

Residue wheels attach to row unit mounted coulters with two cap screws and sleeves allowing unit to free-float. A 2-position spindle bolt mounting positions wheels interlocked or staggered. Depth adjustment is made with a spring-loaded cam and pin with 11 positions in ¼" (~6 mm) increments. A high point on the cam allows wheels to be locked up.

A weed guard on the inboard side of each wheel helps prevent weed wrap which can cause premature bearing failure.

GRANULAR CHEMICAL HOPPER AND DRIVE

 WARNING	<p>Agricultural chemicals can cause death or serious injury to persons, animals, and plants or seriously damage soil, equipment or property. Read and follow all chemical and equipment manufacturers labels and instructions.</p>
	

The granular chemical hopper has a 40 l capacity.

Make sure no foreign objects get into hopper when it is being filled. Replace hopper lids after filling to prevent accumulation of dirt and moisture.

A metering gate on bottom of hopper regulates the application rate. See ["Dry Insecticide Application Rates" on page 5-10](#). Calibrate using chemical manufacturers' instructions.



Granular chemical hopper

Granular chemical clutch drive coupler and meter shaft can be disengaged and engaged by turning throwout knob at rear of hopper support panel.

Rotate knob ¼ turn counterclockwise to disengage and ¼ turn clockwise to engage.

Slotted holes in hopper support panel and clutch housing allow for alignment adjustment between clutch drive coupler and meter shaft.



Granular chemical drive release

SPRING TOOTH INCORPORATOR

Spring tooth incorporator smooths soil behind row unit and incorporates granular chemicals.

Adjust two mounting chains on each spring tooth incorporator so there is approximately 3 mm slack in chain when unit is lowered to planting position.

NOTE: Spring tooth incorporator is not compatible with covering discs/single press wheel option.

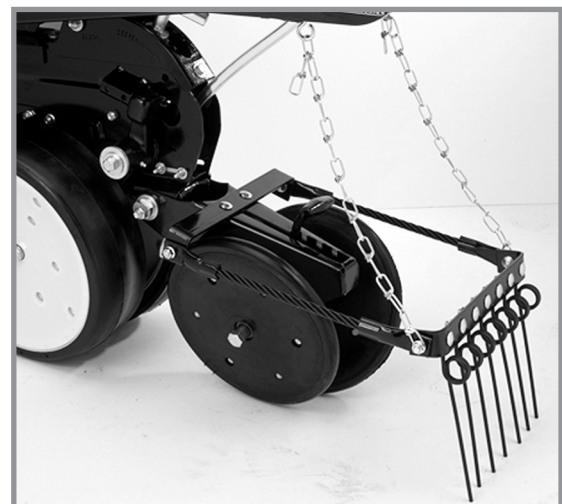

Spring tooth incorporator

GRANULAR CHEMICAL BANDING OPTIONS

Granular chemical banding options allow 4½" (~12 cm) slope-compensating banding, straight drop in-furrow placement or 14" (~36 cm) rear banding.

NOTE: Granular chemical rear bander is not compatible with covering discs/single press wheel option.

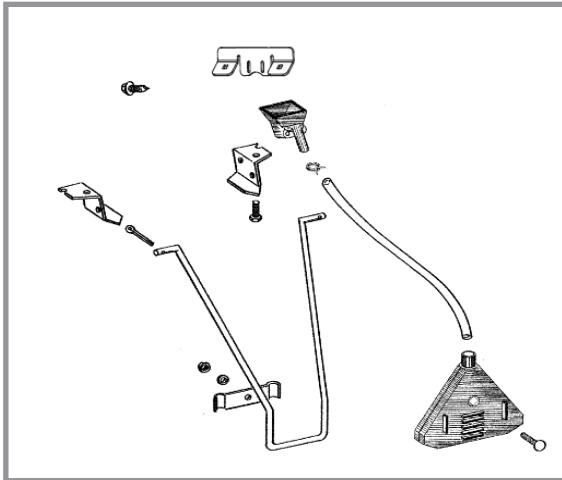

14" (~36 cm) Rear Banding

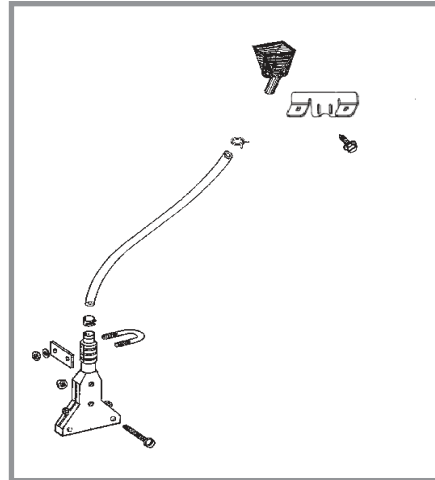

4½" (~12 cm) Slope-Compensating Bander

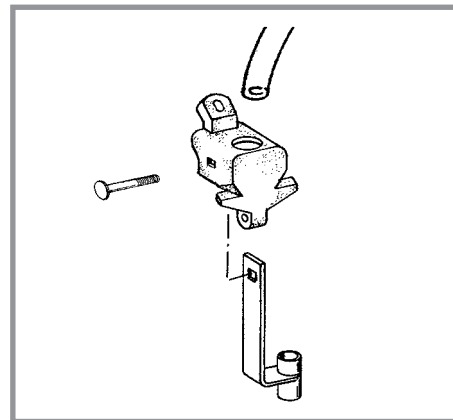

Straight Drop In-Furrow Placement

GRANULAR CHEMICAL BANDER SHIELD

Optional granular chemical bander shield is installed on underside of wheel arm stop to shield crop residue from lodging in granular chemical bander.

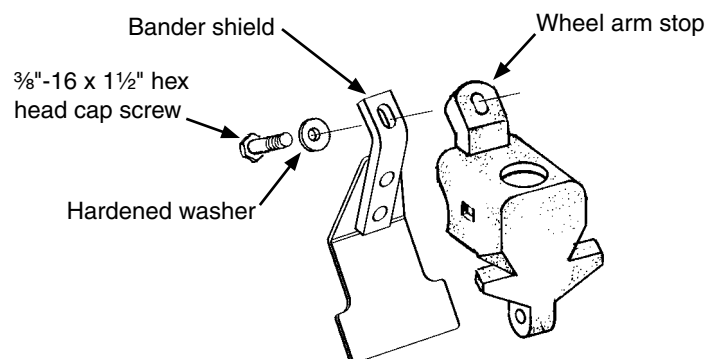

Granular chemical bander shield installation

DOUBLE DISC FERTILIZER OPENER

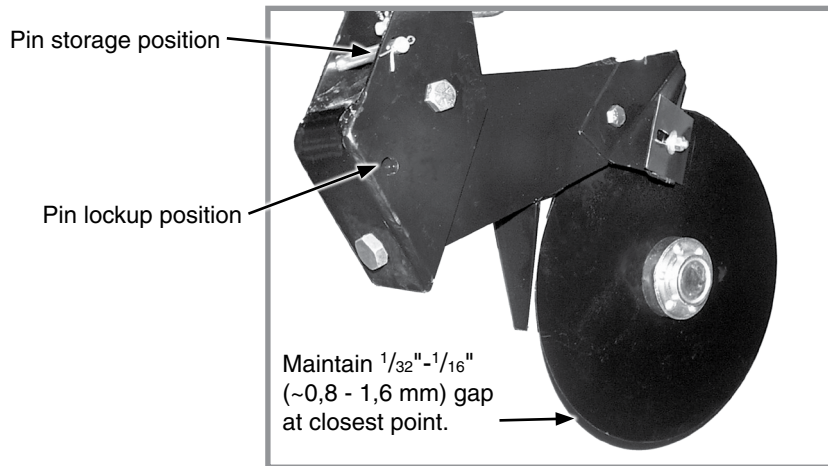

Double disc fertilizer opener

Position double disc fertilizer openers **to place fertilizer no closer than 2" (5 cm) to either side of row**. Fertilizer depth is approximately 4" (~10 cm). If planter frame is level and at proper 20" (~51 cm) operating height. Soil conditions can affect depth slightly.

NOTE: Do not set opener depth with spring pressure. Opener is designed to operate against a depth stop and spring up when encountering a foreign object or hard ground.

Down pressure spring is factory preset at 250 lb (~113 kg) but can be adjusted for various soil conditions.

1. Loosen jam nut with a $1\frac{5}{16}$ " wrench.
2. Use a 1" wrench to turn adjustment bolt clockwise to increase tension or counterclockwise to decrease tension.
3. Tighten jam nut.

NOTICE

Do not operate double disc openers at full down pressure tension on rocky ground or disc blades will chip.

Maintain a gap of $1/32$ "- $1/16$ " (~0,8 - 1,6 mm) between opener blades at the closest point. Blade adjustment is made by moving inside spacer washers to outer side of blade. Check bearing assembly rivets are not contacting shank after making adjustment.

Outer scrapers on each disc blade can be adjusted for wear. Make sure scrapers are adjusted to allow only slight blade contact.

Opener assembly is designed to be locked in a raised position when fertilizer attachment is not in use or during storage.

1. Raise planter and place blocks under openers.
2. Lower planter until pivot section hole aligns with mounting bracket hole.
3. Remove lockup pin from mounting bracket storage position and install through lockup hole.
4. Secure with cotter pins.

NOTCHED SINGLE DISC OPENER

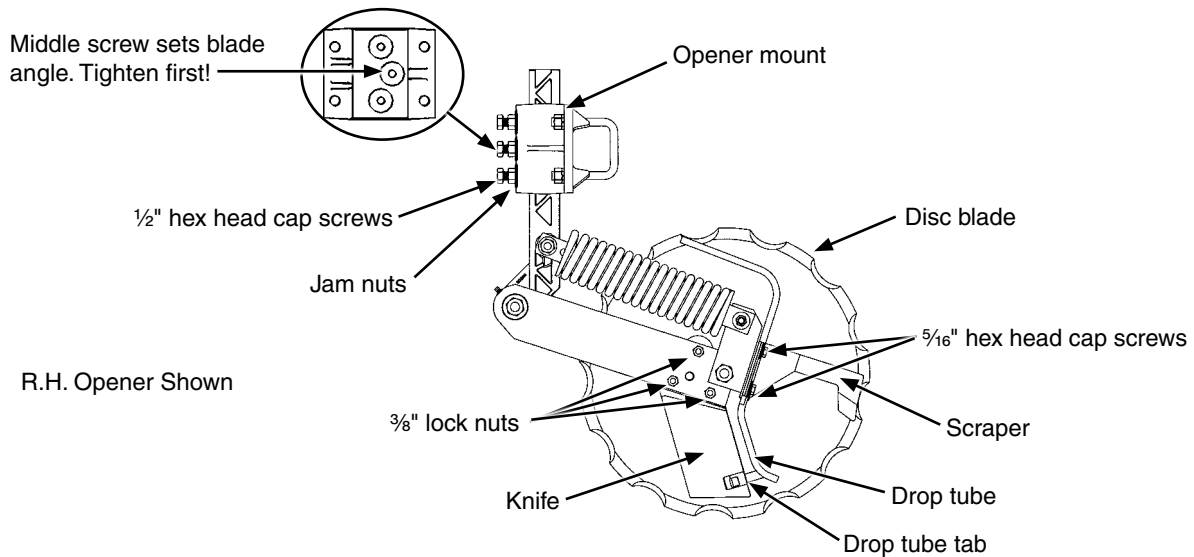

Notched single disc opener adjustments



Compressed spring may fly out of this assembly if attempting to disassemble and cause injury. Do not take apart this assembly.

Disc blades are sharp and can cut causing serious injury. Wear gloves when working on or turning disc blades by hand.



Never strike knife with heavy object. Damage to knife will occur.

If knife to disc blade clearance is too large, soil or residue can wedge between knife and blade, and blade will not turn.

1. Adjust knife to disc blade contact. Loosen or tighten 3/8" lock nuts to adjust knife's entire leading edge against disc blade. Turn blade and check for slight resistance without freewheeling. Readjust knife to blade's tight spot as needed.



Adjust liquid drop tube out of path of soil flow across knife. Drop tube and tab wear quickly if not correctly adjusted.

2. Adjust scraper and drop tube. Loosen two $\frac{5}{16}$ " hex head cap screws. Adjust scraper until just touching disc blade. Adjust drop tube until it is centered between knife and disc blade. Tighten screws. Turn blade and check for slight resistance without freewheeling. Repeat as needed. Insert flat bladed pry bar or screwdriver between knife and drop tube above drop tube tab. Carefully bend tube until $\frac{1}{4}$ "- $\frac{3}{8}$ " (~6 - 10 mm) from disc blade.
3. Adjust blade depth. Loosen three $\frac{1}{2}$ " hex head cap screws and jam nuts in opener mount. Adjust opener assembly up or down to desired blade depth. Tighten center hex head cap screw and jam nut first to set proper disc blade angle. Tighten remaining hex head cap screws and jam nuts. Torque hex head cap screws and jam nuts to 57 ft-lb (~77 Nm). Check fertilizer hose clearance and adjust as necessary.

DEPTH/GAUGE WHEEL ATTACHMENT FOR NOTCHED SINGLE DISC FERTILIZER OPENER

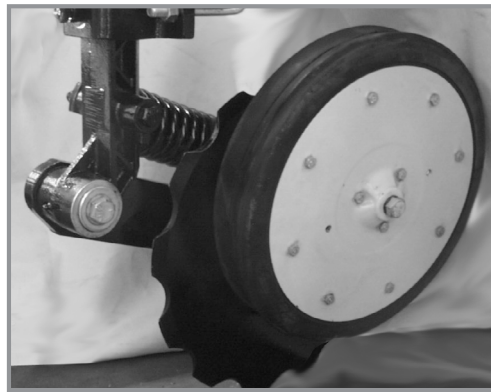

Notched single disc opener depth/gauge wheel

Depth/gauge wheel attachment for notched single disc fertilizer opener is used where additional gauging is required to maintain desired fertilizer opener depth. Depth/gauge wheel is attached to notched single disc fertilizer opener using a mounting block fastened to the pivot arm with $\frac{5}{8}$ " hardware through disc blade bearing.

Depth adjustment is made using 3 adjustment holes in depth/gauge wheel mounting block. Moving depth/gauge wheel increases/decreases depth in approximate 1" (~2,5 cm) increments in relation to blade depth setting made at vertical mounting post.

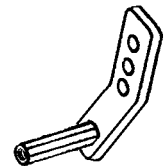

DRY FERTILIZER ATTACHMENT



Agricultural chemicals can cause death or serious injury to persons, animals, and plants or seriously damage soil, equipment, or property. Read and follow all chemical and equipment manufacturers labels and instructions.



Dry fertilizer option installed

Fertilizer drive rate transmission

Rate of fertilizer application is determined by drive/driven sprocket combination on fertilizer drive rate transmission and auger position in the hoppers.



Augers positioned for high rate delivery



Augers positioned for low rate delivery

NOTE: Uneven delivery of fertilizer will occur if high rate auger position is used at too low a rate setting.

Remove 1/4" stainless steel cap screws holding augers in place on shaft and reposition augers to change delivery rate.

A fertilizer transmission is located directly ahead of row unit transmission at the center of the planter and allows simple, rapid changes in sprockets to obtain desired fertilizer application rates. Chain tension is controlled by a spring loaded idler adjusted with a ratchet arm located to inside of transmission. Sprockets can be changed with those on the sprocket storage rod by removing hexagon shaft pins. Fertilizer rate charts in Rate Chart section will help you select correct sprocket combinations.

NOTE: Make a field check after each sprocket combination adjustment to be sure you are applying fertilizer at desired rate.

NOTICE

Placing fertilizer too close to seeds or in excessive amounts can cause germination or seedling damage. Check with your fertilizer dealer or manufacturer for correct amount and placement.

Because dry fertilizer attachment meters granules by volume rather than weight, differences in brands, and fertilizer analysis, weight metered during actual application may vary considerably. Use chart for reference only. Use a container to catch and measure application for a better estimate.

Keep fertilizer dry during use and storage since most fertilizers easily absorb moisture. In addition to waste, deposits of fertilizer left in hopper can cause metal corrosion. Empty hoppers at end of each day.

FIELD CHECK GRANULAR CHEMICAL APPLICATION

Temperature, humidity, speed, ground conditions, flowability of different material, or meter obstructions can affect granular chemical rate of delivery.



WARNING

Agricultural chemicals can cause death or serious injury to persons, animals, and plants or seriously damage soil, equipment, or property. Read and follow all chemical and equipment manufacturers labels and instructions.

Perform a field check to determine application rates.

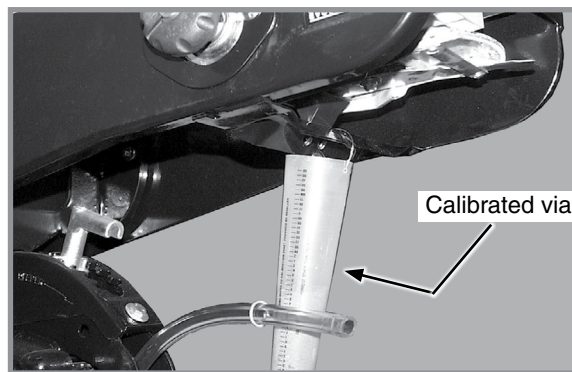

Granular chemical field check

1. Fill insecticide and/or herbicide hoppers.
2. Attach a calibrated vial to each granular chemical meter.

NOTE: Disengage clutch to avoid dropping seed during test.

3. Lower planter and drive 400 meters at planting speed.
4. Weigh chemical in grams caught in one vial.
5. Multiply that amount by factor shown to determine kilograms per hectare.

Kilograms Per Hectare	
Row Width	Factor
70 cm	0,0357

EXAMPLE: You are planting 70 cm rows. You have planted for 400 meters at desired planting speed. You caught 337 grams of chemical in one vial. 337 grams times 0,0357 equals 12 kilograms per hectare.

NOTE: Check calibration of all rows.

METERING GATE

Use metering gate setting as a starting point for distributing insecticide or herbicide. Charts are based on 5 mph (8 km/h) planting speed. Use a higher gate setting for speeds faster than 5 mph (~8 km/h) and a lower setting for speeds slower than 5 mph (~8 km/h).

CLEANING Dry Fertilizer Tanks

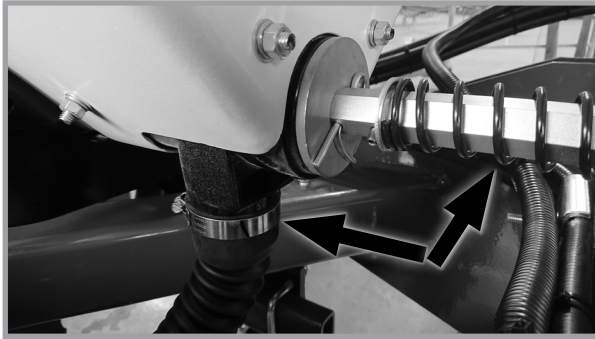
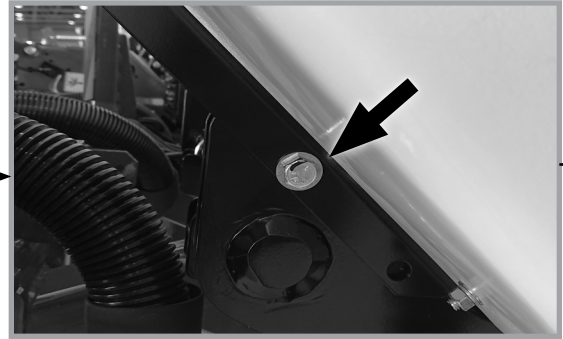
**Disconnect drive shaft and hoses****Undo and remove the cap screw****Rotate lid to back and rotate hopper forward**

Dry fertilizer hoppers tip forward for dumping and ease of cleaning. Disconnect drive shaft from transmission and/or adjacent hopper. **LOOSEN HOSE CLAMPS AND REMOVE HOSES FROM EACH HOPPER.** Remove rear 1/2" x 3" cap screw from between each hopper saddle and hopper mount. Rotate each hopper lid to back side of hopper and carefully tip hopper forward. Flush all loose fertilizer from hoppers and hoses after dumping contents.

At end of planting season or when fertilizer attachment is not used for a longer period of time, hoppers should be disassembled, cleaned, and metal surfaces coated with a rust preventative. Remove 1/4" cotter pin and bearing from one end of shaft. Pull auger assembly from opposite end of hopper. Remove stainless steel cap screws from auger shaft and remove all auger components for cleaning. Coat all parts with rust preventative before reassembly. Reinstall auger halves in low or high rate position.

Auger Installation

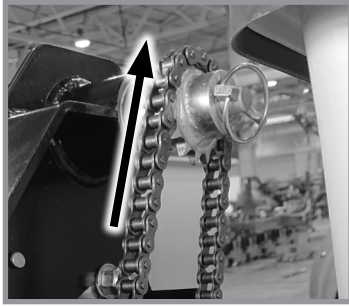

Transmission direction of rotation

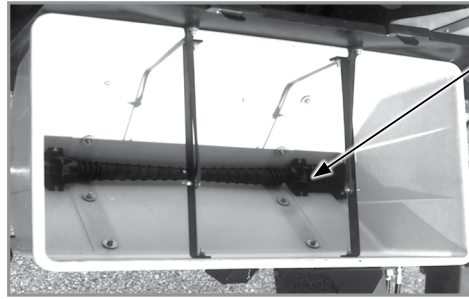

Flighting must move chemicals from center to outside of hopper.

NOTE: Install auger assembly so the flighting moves material to outer openings in hopper when augers rotate in direction they turn during operation.

Slide auger assembly through outlet housing into hopper. Secure in place by reinstalling bearing and cotter pin. Rotating shaft in direction shown to see if flighting (spirals) on auger move toward ends of hopper. If not, remove auger assembly, turn 180°, and reinstall.

NOTE: Frequent lubrication of auger bearings is critical to ensure augers turn freely. [Check "Lubrication and Maintenance" on page 6-1.](#) Be certain augers turn freely. If not, loosen $\frac{5}{16}$ " carriage bolts in outlet housings, rotate auger several times, and retighten carriage bolts. This allows housings and augers to realign.

NOTE: Do not operate fertilizer attachment without auger baffles in place.

Install auger baffles over augers and secure in place with two hair pin clips in each hopper.

GENERAL PLANTING RATE INFORMATION

These planting rate charts apply to Kinze Model 3030 Wing Fold Planters.

NOTICE

Sprocket combinations in these charts are for average conditions. Changes in sprocket combinations may be required for desired planting population. **ALWAYS MAKE FIELD CHECKS TO BE SURE YOU ARE PLANTING AT THE DESIRED RATE.**

NOTICE

Seed additives added in the hopper may affect finger pickup seed meter performance and accelerate wear.

NOTE: Seed size and shape may affect planting rate.

NOTE: Not all row spacings listed apply to all size planters.

NOTE: Speeds above 6.0 MPH (~10 km/h) can adversely affect seed spacing.

NOTE: Planting rates over 672500 seeds/hectare are not recommended.

MECHANICAL

Finger Pickup Corn Meter

Larger grades generally plant more accurately at the high end of ground speed range than smaller grades. Higher than optimum speeds may result in population rate increase or higher incidence of doubles, particularly with small seed. Medium round corn seed is most desirable for planting accuracy at optimum speed.

Finger Pickup Oil Sunflower Meter

Larger grades generally plant more accurately at the high end of ground speed range than smaller grades. Higher than optimum speeds may result in population rate increase or higher incidence of doubles, particularly with small seed. No. 3 and/or No. 4 size oil sunflower seeds are recommended for use in finger pickup seed meters equipped with oil sunflower fingers. No. 1 and/or No. 2 size confectionery sunflower seeds are recommended for use in finger pickup seed meters equipped with corn fingers.

Brush-Type Seed Meter (Soybean, Milo/Grain Sorghum, Acid-Delinted Cotton)

Rate charts are given in seeds per hectare as well as seed spacing in centimeters rounded to nearest tenth of a cm. Because of large range in seed size, kilograms per hectare is not a suggested method of selecting transmission settings. Smaller size seed kilograms per hectare may be below what was expected and large seed kilograms per hectare may appear above expectations. To determine kilograms per hectare, use formula given in "[Determining Kilograms Per Hectare \(Brush-Type Meter\)](#)" on page 2-26 " and "[Check Seed Population](#)" on page 2-25.

NOTE: Planting speed can affect actual seeding rate. Make a field check and adjust transmission setting to obtain desired seed drop.

NOTE: Seed population per hectare with 35 cm rows double rate for 70 cm rows, at listed sprocket combination. See following pages.

NOTE: Half Rate (2 to 1) Drive Reduction Package may be required to obtain desired population and seed spacing when planting 35 cm row soybeans or other crops. Half Rate Drive with brush-type seed meters reduces planter transmission speed. Seeding rate will be approximately 50% of chart reading when using Half Rate (2 To 1) Drive Reduction Package.

EXAMPLE: 70 cm row spacing using 60 cell seed discs in brush-type seed meters.
 $80928 \div 2 = 40464$ Population (6,5 cm Seed Spacing x 2 = 13 cm Seed Spacing)

VACUUM

NOTE: 22, 28, and 44 tooth drive sprockets are NOT applicable to all rate charts. Check chart titles to ensure proper rate chart is selected. 22 tooth sprocket requires 114 pitch No. 40 chain. 28 tooth sprocket requires 118 pitch No. 40 chain. 44 tooth sprocket requires 126 pitch No. 40 chain.

NOTE: DO NOT USE 44 tooth sprockets (60 cell soybean discs) with Dry Fertilizer Package or Liquid Fertilizer Package.

**PLANTING RATES FOR FINGER PICKUP SEED METERS (STANDARD DRIVE)
APPROXIMATE SEEDS/HECTARE FOR 70 CM ROW WIDTH**

70 cm Rows	Transmission Sprockets		Recomm. Speed Range (km/h)	Average Seed Spacing In Centimeters
	Drive	Driven		
43539	17	28	6 to 10	32,7
45150	17	27	6 to 10	31,7
46888	17	26	6 to 10	30,4
48661	19	28	6 to 10	29,4
48763	17	25	6 to 10	29,2
50463	19	27	6 to 10	28,1
50794	17	24	6 to 10	28,1
52402	19	26	6 to 10	27,1
53002	17	23	6 to 10	26,9
54500	19	25	6 to 10	26,1
56768	19	24	6 to 10	25,1
58904	23	28	6 to 10	24,1
59237	19	23	6 to 10	24,1
61085	23	27	6 to 10	23,3
61465	24	28	6 to 10	23,3
63436	23	26	6 to 10	22,6
63743	24	27	6 to 10	22,3
64025	25	28	6 to 10	22,3
64163	17	19	6 to 10	22,3
65973	23	25	6 to 10	21,5
66194	24	26	6 to 10	21,5
66398	25	27	6 to 10	21,5
66589	26	28	6 to 10	21,3
68722	23	24	6 to 10	20,8
68840	24	25	6 to 10	20,8
68951	25	26	6 to 10	20,8
69053	26	27	6 to 10	20,5
69150	27	28	6 to 10	20,5
71711	23	23	6 to 10	19,8
74366	28	27	6 to 10	19,3
74468	27	26	6 to 10	19,3
74699	25	24	6 to 10	19,0
74828	24	23	6 to 10	19,0
77225	28	26	6 to 10	18,5
77445	27	25	6 to 10	18,5
77946	25	23	6 to 10	18,3
80146	19	17	6 to 10	17,7
80316	28	25	6 to 10	17,7
80673	27	24	6 to 10	17,7
81063	26	23	6 to 10	17,7
83662	28	24	5 to 10	17,0
84181	27	23	5 to 10	17,0
86806	23	19	5 to 9	16,5
87299	28	23	5 to 9	16,5
90580	24	19	3 to 5,5	15,7
94354	25	19	4 to 8	15,2
97020	23	17	4 to 8	14,7
98128	26	19	4 to 8	14,4
101238	24	17	4 to 8	14,2
101902	27	19	4 to 8	13,9
105456	25	17	5 to 7	13,4
105679	28	19	5 to 7	13,4
109673	26	17	5 to 7	12,9
113891	27	17	5 to 7	12,4
118109	28	17	5 to 7	12,2

NOTE: See ["General Planting Rate Information"](#) on page 5-1 and ["Check Seed Population"](#) on page 2-25" for additional information.

**PLANTING RATES FOR BRUSH-TYPE SEED METERS (STANDARD DRIVE)
APPROXIMATE SEEDS/HECTARE FOR 70 CM ROW WIDTH**

Transmission Sprockets		60 Cell Soybean Or High-Rate Milo/Grain Sorghum	Average Seed Spacing in Centimeters	48 Cell Specialty Soybean Or High-Rate Acid-Delinted Cotton	Average Seed Spacing in Centimeters	Speed Range (km/h)
Drive	Driven					
17	28	217690	6,6	174151	8,1	3 to 13
17	27	225754	6,3	180604	7,8	3 to 13
17	26	234437	6,0	187549	7,6	3 to 13
19	28	243301	5,8	194640	7,3	3 to 13
19	27	252312	5,5	201849	7,1	3 to 13
17	24	253971	5,5	203178	7,1	3 to 13
17	23	265014	5,3	212011	6,8	3 to 13
19	25	272497	5,3	217996	6,6	3 to 13
19	24	283851	5,0	227080	6,6	3 to 13
23	28	294522	4,8	235618	6,0	3 to 13
19	23	296192	4,8	236955	6,0	3 to 13
24	28	307329	4,5	245864	5,8	3 to 13
24	27	318710	4,5	254967	5,5	3 to 13
17	19	320808	4,5	256645	5,5	3 to 13
24	26	330968	4,3	264774	5,3	3 to 13
26	28	332939	4,3	266350	5,3	3 to 13
24	25	344208	4,0	275367	5,0	3 to 13
26	27	345270	4,0	276217	5,0	3 to 13
23	23	358550	4,0	286840	5,0	3 to 13
27	26	372339	3,8	297871	4,8	3 to 13
24	23	374138	3,8	299310	4,8	3 to 13
25	23	389726	3,5	311781	4,5	3 to 13
19	17	400731	3,5	320585	4,5	3 to 13
27	24	403367	3,5	322694	4,3	3 to 13
28	24	418307	3,3	334645	4,3	3 to 13
23	19	434032	3,3	347226	4,0	3 to 13
28	23	436493	3,3	349195	4,0	3 to 13
24	19	452905	3,0	362321	4,0	3 to 13
25	19	471774	3,0	377420	3,8	3 to 13
23	17	485095	3,0	388075	3,8	3 to 13
26	19	490647	2,7	392519	3,5	3 to 11
27	19	509517	2,7	407614	3,5	3 to 11
28	19	528389	2,7	422710	3,3	3 to 11
26	17	548370	2,5	438696	3,3	3 to 11
27	17	569461	2,2	455570	3,0	3 to 11
28	17	590550	2,2	472441	3,0	3 to 11

NOTE: See "[General Planting Rate Information](#)" on page 5-1 and "[Check Seed Population](#)" on page 2-25" for additional information.

NOTE: Half Rate (2 To 1) Drive Reduction rates are approximately 50% of given numbers.

NOTE: Always field check seed population to ensure planting rates are correct.

**PLANTING RATES FOR BRUSH-TYPE SEED METER (STANDARD DRIVE)
APPROXIMATE SEEDS/HECTARE FOR 35 CM ROW WIDTH**

Transmission Sprockets		60 Cell Soybean Or High-Rate Milo/ Grain Sorghum	Average Seed Spacing in Centimeters	48 Cell Specialty Soybean Or High-Rate Acid-Delinted Cotton	Average Seed Spacing in Centimeters	Speed Range (km/h)
Drive	Driven					
		35 cm Rows		35 cm Rows		
17	28	435379	6,6	348301	8,1	3 to 13
17	27	451508	6,3	361208	7,8	3 to 13
17	26	468874	6,0	375098	7,6	3 to 13
19	28	486601	5,8	389280	7,3	3 to 13
19	27	504623	5,5	403698	7,1	3 to 13
17	24	507943	5,5	406355	7,1	3 to 13
17	23	530027	5,3	424023	6,8	3 to 13
19	25	544994	5,3	435993	6,6	3 to 13
19	24	567702	5,0	454160	6,6	3 to 13
23	28	589044	4,8	471236	6,0	3 to 13
19	23	592385	4,8	473910	6,0	3 to 13
24	28	614657	4,5	491728	5,8	3 to 13
24	27	637419	4,5	509933	5,5	3 to 13
17	19	641616	4,5	513290	5,5	3 to 13
24	26	661935	4,3	529548	5,3	3 to 13
26	28	665879	4,3	532701	5,3	3 to 13
24	25	688415	4,0	550734	5,0	3 to 13
26	27	690540	4,0	552434	5,0	3 to 13
23	23	717100	4,0	573679	5,0	3 to 13
27	26	744677	3,8	595742	4,8	3 to 13
24	23	748276	3,8	598620	4,8	3 to 13
25	23	779452	3,5	623561	4,5	3 to 13
19	17	801461	3,5	641169	4,5	3 to 13
27	24	806733	3,5	645387	4,3	3 to 13
28	24	836613	3,3	669289	4,3	3 to 13
23	19	868064	3,3	694451	4,0	3 to 13
28	23	872986	3,3	698389	4,0	3 to 13
24	19	905809	3,0	724643	4,0	3 to 13
25	19	943548	3,0	754840	3,8	3 to 13
23	17	970189	3,0	776149	3,8	3 to 13
26	19	981293	2,7	785037	3,5	3 to 11
27	19	1019033	2,7	815228	3,5	3 to 11
28	19	1056778	2,7	845420	3,3	3 to 11
26	17	1096739	2,5	877392	3,3	3 to 11
27	17	1138922	2,2	911140	3,0	3 to 11
28	17	1181100	2,2	944882	3,0	3 to 11

NOTE: See "[General Planting Rate Information](#)" on page 5-1 and "[Check Seed Population](#)" on page 2-25" for additional information.

NOTE: Half Rate (2 To 1) Drive Reduction rates are approximately 50% of given numbers.

NOTE: Always field check seed population to ensure planting rates are correct.

**PLANTING RATES FOR BRUSH-TYPE SEED METERS (STANDARD DRIVE)
APPROXIMATE SEEDS/HECTARE FOR 70 CM ROW WIDTH**

Transmission Sprockets		36 Cell Acid-Delinted Large Cotton	Average Seed Spacing In Centimeters	30 Cell Milo / Grain Sorghum or Acid-Delinted Cotton	Average Seed Spacing in Centimeters	Speed Range (km/h)
Drive	Driven					
17	28	130614	10,9	108845	13,2	3 to 13
17	27	135454	10,6	112877	12,7	3 to 13
17	26	140661	10,1	117219	12,1	3 to 13
19	28	145979	9,9	121652	11,6	3 to 13
19	27	151386	9,3	126157	11,4	3 to 13
17	24	152384	9,3	126986	11,1	3 to 13
17	23	159009	8,8	132508	10,6	3 to 13
19	25	163499	8,8	136250	10,4	3 to 13
19	24	170310	8,3	141926	10,1	3 to 13
23	28	176714	8,1	147262	9,5	3 to 13
19	23	177715	8,1	148096	9,5	3 to 13
24	28	184397	7,6	153664	9,3	3 to 13
24	27	191226	7,3	159356	8,8	3 to 13
17	19	192485	7,3	160403	8,8	3 to 13
24	26	198581	7,1	165484	8,6	3 to 13
26	28	199764	7,1	166468	8,6	3 to 13
24	25	206511	6,8	172104	8,3	3 to 13
26	27	207161	6,8	172634	8,3	3 to 13
23	23	215129	6,6	179275	7,8	3 to 13
27	26	223403	6,3	186169	7,6	3 to 13
24	23	224482	6,3	187068	7,6	3 to 13
25	23	233835	6,0	194863	7,3	3 to 13
19	17	240438	5,8	200367	7,1	3 to 13
27	24	242020	5,8	201685	7,1	3 to 13
28	24	250983	5,5	209155	6,8	3 to 13
23	19	260419	5,5	217017	6,6	3 to 13
28	23	261896	5,3	218247	6,6	3 to 13
24	19	271744	5,3	226451	6,3	3 to 13
25	19	283066	5,0	235887	6,0	3 to 13
23	17	291138	4,8	242547	5,8	3 to 13
26	19	294388	4,8	245323	5,8	3 to 11
27	19	305709	4,5	254760	5,5	3 to 11
28	19	317034	4,5	264193	5,3	3 to 11
26	17	329023	4,3	274184	5,3	3 to 11
27	17	341676	4,0	284731	5,0	3 to 11
28	17	354330	4,0	295275	4,8	3 to 11

NOTE: See "[General Planting Rate Information](#)" on page 5-1 and "[Check Seed Population](#)" on page 2-25" for additional information.

NOTE: Half Rate (2 To 1) Drive Reduction rates are approximately 50% of given numbers.

NOTE: Always field check seed population to ensure planting rates are correct.

**PLANTING RATES FOR BRUSH-TYPE SEED METERS (STANDARD DRIVE)
APPROXIMATE HILLS/HECTARE FOR 70 CM ROW WIDTH**

Due to variations in cotton seed size, meters equipped with 12 cell acid-delinted hill-drop cotton discs plant from 3 to 6 seeds per cell. Select proper disc for seed size range to be planted.

To determine planter transmission setting, determine desired hill spacing and select transmission ratio closest to hill spacing in centimeters on chart. To decrease population, increase spacing. To increase population decrease spacing.

To determine population per hectare, determine average seeds per hill and hills per hectare by doing a field check. Measure 1/1000 of an hectare (1/10 hectare = Length of row 14,28 meters for 70cm row widths). Multiply average seeds per hill by hills per hectare. Example: 4 seeds per hill x (13 hills x 1000) = 52000.

Transmission Sprockets		NUMBER OF HILLS PER HECTARE 12 Cell Hill-Drop Cotton, Acid-Delinted 70 cm Rows	Average Hill Spacing In Centimeters	Speed Range (km/h)
Drive	Driven			
17	28	43539	32,7	3 to 13
17	27	45150	31,7	3 to 13
17	26	46888	30,4	3 to 13
19	28	48661	29,4	3 to 13
19	27	50463	28,1	3 to 13
17	24	50794	28,1	3 to 13
17	23	53002	26,9	3 to 13
19	25	54500	26,1	3 to 13
19	24	56771	25,1	3 to 13
23	28	58904	24,1	3 to 13
19	23	59237	24,1	3 to 13
24	28	61465	23,3	3 to 13
24	27	63743	22,3	3 to 13
17	19	64163	22,3	3 to 13
24	26	66194	21,5	3 to 13
26	28	66589	21,3	3 to 13
24	25	68840	20,8	3 to 13
26	27	69053	20,5	3 to 13
23	23	71711	19,8	3 to 13
27	26	74468	19,3	3 to 13
24	23	74828	19,0	3 to 13
25	23	77946	18,2	3 to 13
19	17	80146	17,7	3 to 13
27	24	80673	17,7	3 to 13
28	24	83662	17,0	3 to 13
23	19	86806	16,5	3 to 13
28	23	87299	16,5	3 to 13
24	19	90580	15,7	3 to 13
25	19	94354	15,2	3 to 13
23	17	97020	14,7	3 to 13
26	19	98128	14,4	3 to 11
27	19	101902	13,9	3 to 11
28	19	105679	13,4	3 to 11
26	17	109673	12,9	3 to 11
27	17	113891	12,4	3 to 11
28	17	118109	12,1	3 to 11

NOTE: See ["General Planting Rate Information" on page 5-1](#) and ["Check Seed Population" on page 2-25](#) for additional information.

NOTE: Half Rate (2 To 1) Drive Reduction rates are approximately 50% of given numbers.

NOTE: Always field check seed population to ensure planting rates are correct.

**PLANTING RATES FOR VACCUM METER CORN/SUNFLOWER 40 CELL DISC 15 TOOTH CONTACT
WHEEL DRIVE SPROCKET
34 TOOTH SPROCKET HALF RATE KIT INSTALLED**

APPROXIMATE SEEDS/HECTARE

70 cm Rows (Seeds/Hectare)	35 cm Rows (Seeds/Hectare)	Transmission Sprockets		Recomm. Speed (km/h)	Average Spacing (cm)
		Drive	Driven		
40550	81100	15	30	6 to 10	35,2
43447	86894	15	28	6 to 10	32,9
45056	90112	15	27	6 to 10	31,7
45957	91914	17	30*	6 to 10	31,1
46789	93578	15*	26	6 to 10	30,5
48660	97320	15*	25	6 to 10	29,4
49241	98482	17	28	6 to 10	29,0
51063	102126	17	27	6 to 10	28,1
53028	106056	17	26	6 to 10	27,0
55033	110066	19	28	6 to 10	26,1
55149	110298	17	25	6 to 10	25,8
57071	114142	19	27	6 to 10	24,9
57445	114890	17	24	6 to 10	24,9
59265	118530	19	26	6 to 10	24,0
59943	119886	17	23	6 to 10	23,8
61637	123274	19	25	6 to 10	23,1
64202	128404	19	24	6 to 10	22,2
66618	133236	23	28	6 to 10	21,3
66995	133990	19	23	6 to 10	21,3
69085	138170	23	27	6 to 10	20,7
69514	139028	24	28	6 to 10	20,7
71744	143488	23	26	6 to 10	20,0
72090	144180	24	27	6 to 10	19,8
72410	144820	25	28	6 to 10	19,8
72565	145130	17	19	6 to 10	19,8
74612	149224	23	25	6 to 10	19,1
74862	149724	24	26	6 to 10	19,1
75093	150186	25	27	6 to 10	19,1
75309	150618	26	28	6 to 10	18,9
77721	155442	23	24	6 to 10	18,4
77855	155710	24	25	6 to 10	18,4
77980	155960	25	26	6 to 10	18,4
78096	156192	26	27	6 to 10	18,2
78205	156410	27	28	6 to 10	18,2
81101	162202	23	23	6 to 10	17,5
84104	168208	28	27	6 to 10	17,1
84220	168440	27	26	6 to 10	17,1
84481	168962	25	24	6 to 10	16,8
84627	169254	24	23	6 to 10	16,8
87338	174676	28	26	6 to 10	16,4
87587	175174	27	25	6 to 10	16,4
88153	176306	25	23	6 to 10	16,2
90642	181284	19	17	6 to 10	15,7
90833	181666	28	25	6 to 10	15,7
91238	182476	27	24	6 to 10	15,7
91679	183358	26	23	6 to 10	15,7
94618	189236	28	24	6 to 10	15,0
95205	190410	27	23	6 to 10	15,0
98174	196348	23	19	6 to 10	14,6
98731	197462	28	23	6 to 10	14,6
102442	204884	24	19	6 to 10	13,9
106710	213420	25	19	6 to 10	13,5
109725	219450	23	17	6 to 10	13,0
110978	221956	26	19	6 to 10	12,8
114495	228990	24	17	6 to 10	12,6
115247	230494	27	19	6 to 10	12,4
119265	238530	25	17	6 to 10	11,9
119518	239036	28	19	6 to 10	11,9
124035	248070	26	17	6 to 10	11,5
128806	257612	27	17	6 to 10	11,0
133576	267152	28	17	6 to 10	10,8

**PLANTING RATES FOR VACUUM METER SOYBEANS 120 CELL DISC
15 TOOTH CONTACT WHEEL DRIVE SPROCKET
17 TOOTH SPROCKET STANDARD RATE KIT INSTALLED
APPROXIMATE SEEDS/HECTARE**

70 cm Rows (Seeds/Hectare)	35 cm Rows (Seeds/Hectare)	Transmission Sprockets		Recomm. Speed (km/h)	Average Spacing (cm)
		Drive	Driven		
243301	486602	15	30	6 to 10	5,9
260679	521358	15	28	6 to 10	5,5
270334	540668	15	27	6 to 10	5,3
275741	551482	17	30	6 to 10	5,2
280731	561462	15*	26	6 to 10	5,1
291961	583922	15*	25	6 to 10	4,9
295444	590888	17	28	6 to 10	4,8
306377	612754	17	27	6 to 10	4,7
318169	636338	17	26	6 to 10	4,5
330197	660394	19	28	6 to 10	4,3
330891	661782	17	25	6 to 10	4,3
342427	684854	19	27	6 to 10	4,2
344672	689344	17	24	6 to 10	4,2
355587	711174	19	26	6 to 10	4,0
359658	719316	17	23	6 to 10	4,0
369825	739650	19	25	6 to 10	3,9
385212	770424	19	24	6 to 10	3,7
399705	799410	23	28	6 to 10	3,6
401968	803936	19	23	6 to 10	3,6
414508	829016	23	27	6 to 10	3,4
417082	834164	24	28	6 to 10	3,4
430461	860922	23	26	6 to 10	3,3
432542	865084	24	27	6 to 10	3,3
434459	868918	25	28	6 to 10	3,3
435390	870780	17	19	6 to 10	3,3
447674	895348	23	25	6 to 10	3,2
449171	898342	24	26	6 to 10	3,2
450558	901116	25	27	6 to 10	3,2
451854	903708	26	28	6 to 10	3,1
466329	932658	23	24	6 to 10	3,1
467132	934264	24	25	6 to 10	3,1
467880	935760	25	26	6 to 10	3,1
468574	937148	26	27	6 to 10	3,0
469231	938462	27	28	6 to 10	3,0
486608	973216	23	23	6 to 10	2,9
504624	1009248	28	27	6 to 10	2,8
505317	1010634	27	26	6 to 10	2,8
506887	1013774	25	24	6 to 10	2,8
507763	1015526	24	23	6 to 10	2,8
524027	1048054	28	26	6 to 10	2,7
525523	1051046	27	25	6 to 10	2,7
528918	1057836	25	23	6 to 10	2,7
543849	1087698	19	17	6 to 10	2,6
544999	1089998	28	25	6 to 10	2,6
547427	1094854	27	24	6 to 10	2,6
550074	1100148	26	23	6 to 10	2,6
567706	1135412	28	24	6 to 10	2,5
571229	1142458	27	23	6 to 10	2,5
589044	1178088	23	19	6 to 10	2,4
592384	1184768	28	23	6 to 10	2,4
614653	1229306	24	19	6 to 10	2,3
640262	1280524	25	19	6 to 10	2,2
658351	1316702	23	17	6 to 10	2,2
665871	1331742	26	19	6 to 10	2,1

**PLANTING RATES FOR VACUUM METER MILO/SUGAR BEET/SPECIALTY 60 CELL DISC
15 TOOTH CONTACT WHEEL DRIVE SPROCKET
34 TOOTH SPROCKET HALF RATE KIT INSTALLED
APPROXIMATE SEEDS/HECTARE**

70 cm Rows (Seeds/Hectare)	Transmission Sprockets		Recomm. Speed (km/h)	Average Spacing (cm)
	Drive	Driven		
60825	15	30	6 to 10	23,5
65170	15	28	6 to 10	21,9
67584	15	27	6 to 10	21,1
68935	17	30	6 to 10	20,7
70183	15	26	6 to 10	20,4
72990	15	25	6 to 10	19,6
73861	17	28	6 to 10	19,3
76594	17	27	6 to 10	18,7
79542	17	26	6 to 10	18,0
82549	19	28	6 to 10	17,4
82723	17	25	6 to 10	17,2
85607	19	27	6 to 10	16,6
86168	17	24	6 to 10	16,6
88897	19	26	6 to 10	16,0
89914	17	23	6 to 10	15,9
92456	19	25	6 to 10	15,4
96303	19	24	6 to 10	14,8
99926	23	28	6 to 10	14,2
100492	19	23	6 to 10	14,2
103627	23	27	6 to 10	13,8
104270	24	28	6 to 10	13,8
107615	23	26	6 to 10	13,3
108136	24	27	6 to 10	13,2
108615	25	28	6 to 10	13,2
108847	17	19	6 to 10	13,2
111919	23	25	6 to 10	12,7
112293	24	26	6 to 10	12,7
112640	25	27	6 to 10	12,7
112963	26	28	6 to 10	12,6
116582	23	24	6 to 10	12,3
116783	24	25	6 to 10	12,3
116970	25	26	6 to 10	12,3
117143	26	27	6 to 10	12,1
117308	27	28	6 to 10	12,1
121652	23	23	6 to 10	11,7
126156	28	27	6 to 10	11,4
126329	27	26	6 to 10	11,4
126722	25	24	6 to 10	11,2
126941	24	23	6 to 10	11,2
131007	28	26	6 to 10	10,9
131381	27	25	6 to 10	10,9
132230	25	23	6 to 10	10,8
135962	19	17	6 to 10	10,5
136250	28	25	6 to 10	10,5
136857	27	24	6 to 10	10,5
137518	26	23	6 to 10	10,5
141927	28	24	6 to 10	10,0
142807	27	23	6 to 10	10,0
147261	23	19	6 to 10	9,7
148096	28	23	6 to 10	9,7
153663	24	19	6 to 10	9,3
160065	25	19	6 to 10	9,0
164588	23	17	6 to 10	8,7
166468	26	19	6 to 10	8,5
171743	24	17	6 to 10	8,4
172870	27	19	6 to 10	8,2
178898	25	17	6 to 10	7,9
179277	28	19	6 to 10	7,9
186053	26	17	6 to 10	7,6
193208	27	17	6 to 10	7,3
200364	28	17	6 to 10	7,2

**DRY INSECTICIDE APPLICATION RATES
APPROXIMATE KILOGRAMS/HECTARE AT 8 KM/H FOR 70 CM ROW WIDTH**

Meter Setting	70 cm Rows
CLAY GRANULES	
10	6,0
11	6,0
12	7,4
13	8,4
14	9,4
15	10,4
16	11,7
17	13,1
18	13,9
19	16,0
20	17,3
21	18,9
22	20,0
23	21,0
24	22,9
25	25,5
26	28,1
27	29,4
28	31,0
29	33,9
30	36,1
SAND GRANULES	
5	3,5
6	6,0
7	6,5
8	7,7
9	9,5
10	10,9
11	12,4
12	13,7
13	15,4
14	17,6
15	18,9
16	21,4
17	23,7
18	26,6
19	29,6
20	31,4
21	33,7
22	36,1
23	39,0
24	42,0
25	45,0

NOTE: Above chart represents average values and should be used only as a starting point. Granular chemical flows through given meter opening at a nearly uniform rate regardless of roller speed. Your actual rate will vary with specific insecticide, planting speed, and plant population. Planting speed/ground speed has the greatest effect on application rate.

Your actual rate must be field checked with actual insecticide you are using at speed and population you are planting. See ["Field Check Granular Chemical Application" on page 4-5](#) for additional information.

DRY HERBICIDE APPLICATION RATES
APPROXIMATE KILOGRAMS/HECTARE AT 8 KM/H FOR 70 CM ROW WIDTHS

CLAY GRANULES

Meter Setting	70 cm Rows
10	5,7
11	6,0
12	7,1
13	7,9
14	8,9
15	10,0
16	11,0
17	12,1
18	13,1
19	14,2
20	15,4
21	16,6
22	17,8
23	19,2
24	20,7
25	22,1
26	23,7
27	25,5
28	27,6
29	29,6
30	32,6

NOTE: Above chart represents average values and should be used only as a starting point. Granular chemical flows through given meter opening at a nearly uniform rate regardless of roller speed. Your actual rate will vary depending on specific herbicide, planting speed, and plant population. Planting speed/ground speed has the greatest effect on application rate.

Your actual rate must be field checked with actual herbicide you are using at speed and population you are planting. See ["Field Check Granular Chemical Application"](#) on page 4-5 for additional information.

**DRY FERTILIZER APPLICATION RATES
APPROXIMATE RATE IN KG PER HECTARE**

Drive Sprocket	Driven Sprocket	Low Rate Position	High Rate Position
		70 cm Rows	70 cm Rows
15	35	39	115
15	33	44	133
15	30	48	147
19	33	55	165
19	30	61	187
15	19	71	213
30	35	75	230
30	33	82	245
33	35	84	252
35	33	93	262
33	30	99	295
19	15	114	340
30	19	142	424
33	19	155	467
35	19	163	492
30	15	179	538
33	15	197	589
35	15	205	624



High rate setting

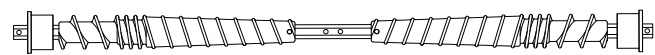

Low rate setting

NOTE: Uneven delivery may result from attempting to use lower rates than indicated by chart.

Above chart is for planters equipped with contact drive. Check tires for correct operating pressure.

Chart calculated with a bulk density of 1041 kilograms per cubic meter.

NOTE: Fertilizer application rates can vary from weights calculated in above chart. Make field checks to be sure you are applying fertilizer at desired rate.

To check exact number of kilograms your fertilizer attachment will actually deliver on 70 cm row spacing:

1. Remove one spout from one fertilizer hopper and attach a container under opening.
2. Engage fertilizer attachment and drive forward 14,28 m.
3. Weigh amount of fertilizer caught in container and multiply by 100. Result is kilograms of fertilizer delivered per hectare when planting in 70 cm rows. To convert this delivery rate for wider rows, multiply by following conversion factors:

for 76 cm rows- multiply by 0,92

LUBRICATION

Following pages show locations of all lubrication points. Proper lubrication of moving parts helps ensure efficient operation of your Kinze planter and prolongs the life of friction producing parts.



WARNING

Uncontrolled machine can crush or cause loss of control resulting in death, serious injury, or damage to property and equipment. Install all safety lockup devices before working under or transporting equipment.



LUBRICATION SYMBOLS

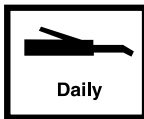

Lubricate at frequency indicated with an SAE multipurpose grease.



Lubricate at frequency indicated with a high quality SAE 10 weight oil or a quality spray lubricant.

SEALED BEARINGS

A number of sealed bearings are used on your Kinze planter to provide trouble free operation. These are located in such areas as the drive shaft, row units, and transmission bearings. Sealed bearings are lubricated for life and not serviceable.

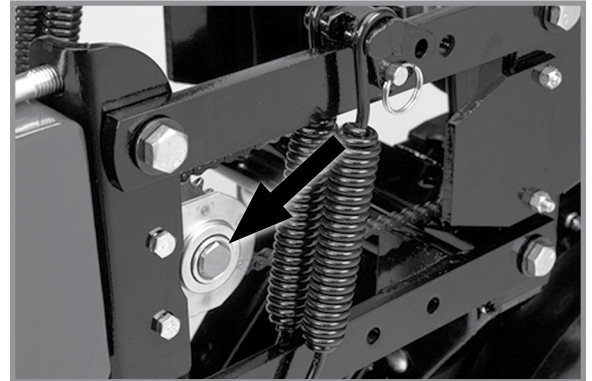

WRAP SPRING WRENCH ASSEMBLY

Components may require occasional lubrication to operate correctly. Disassembly is required to lubricate.

1. Remove ¼"-20 x ½" cap screw that secures idler assembly to wrap spring wrench tightener shaft.
2. Remove wrap spring wrench from planter.
3. Tip wrap spring wrench on its side and lubricate with a high quality spray lubricant. Lubricant must be absorbed into wrap spring area.
4. Reinstall wrap spring wrench on planter.



Wrap Spring Wrench Lubrication

DRIVE CHAINS

Lubricate all transmission and drive chains daily with a high quality chain lubricant. Extreme operating conditions such as dirt, temperature, or speed may require more frequent lubrication. If a chain becomes stiff, it should be removed, soaked, and washed in solvent to loosen and remove dirt from joints. Soak chain in oil so lubricant can penetrate between rollers and bushings.

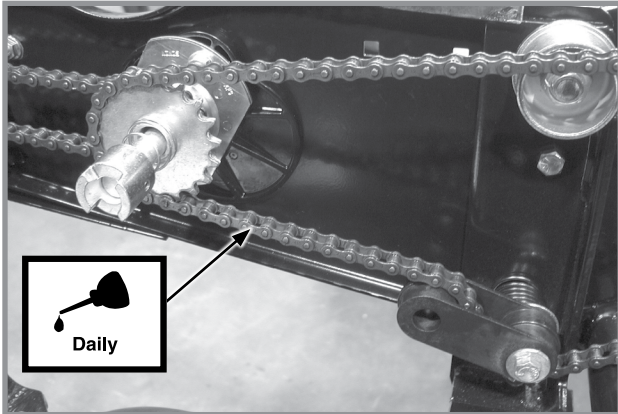

Pull Row Unit Drive Chains

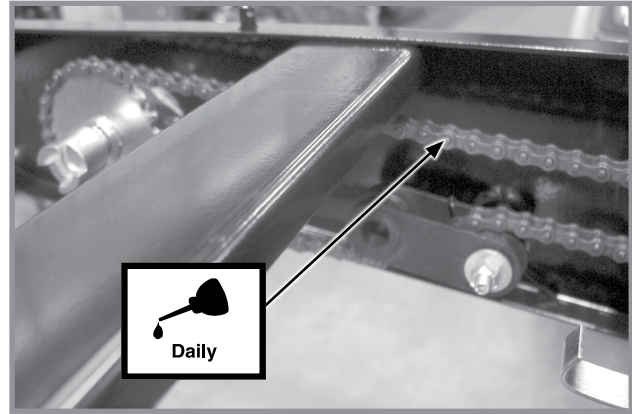

Row Unit Granular Chemical Drive Chains

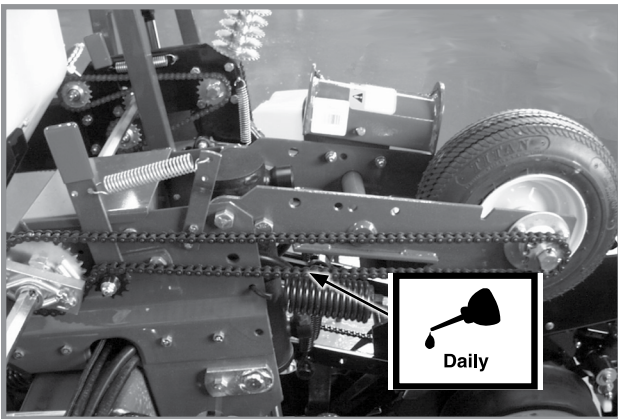

Contact Wheel Drive Chains

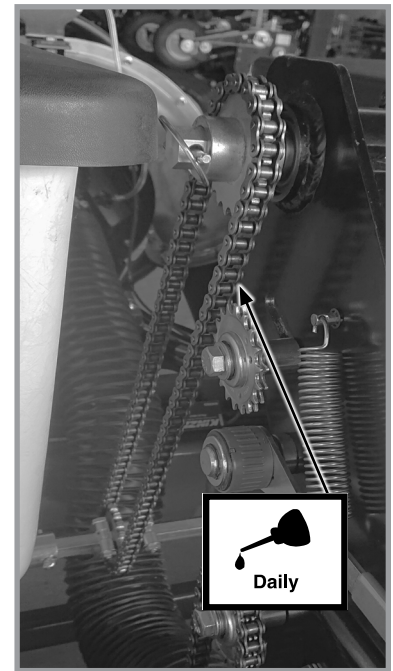
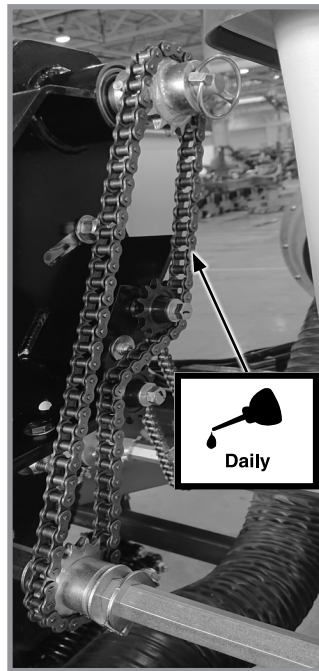

Dry Fertilizer Drive Chain (from both sides of the assembly)

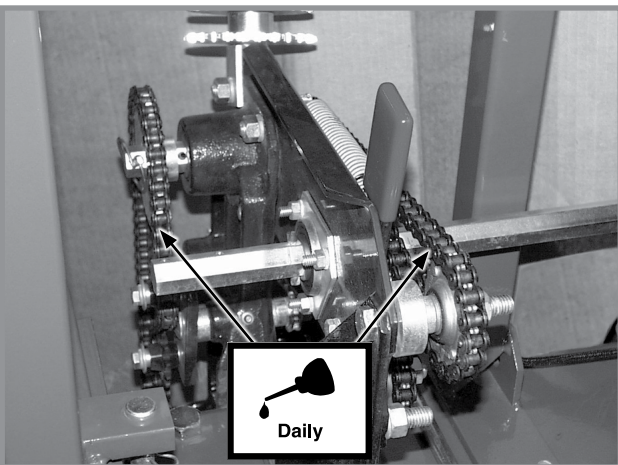

Seed Rate Transmission Assembly and Reverser Plate Chains

BUSHINGS

Lubricate bushings at frequency indicated.

Check each bolt for proper torque. If bolt is loose, removed it and inspect bushing for cracks and wear. Replace bushing if necessary. Use **only hardened flat washers**. Replace damaged flat washers with proper part. Torque hardware to 130 ft-lb (~176 Nm).

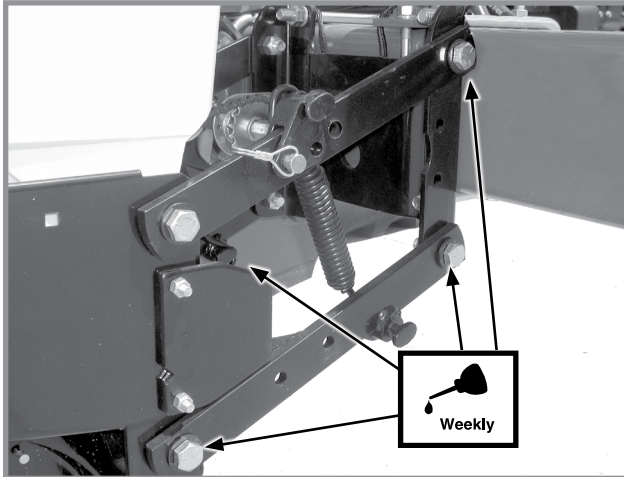

Pull Row Unit Parallel Linkages (8 Per Row)

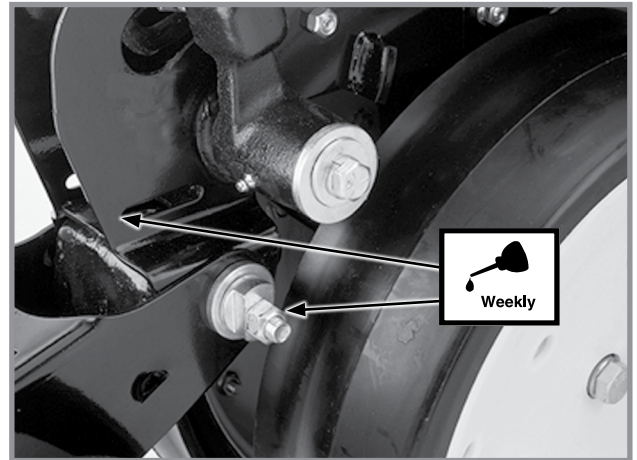

**Row Unit "V" Closing Wheel, Covering Discs/
Single Press Wheel And/Or Drag Closing Wheel
Eccentric Bushings (2 Per Row)**

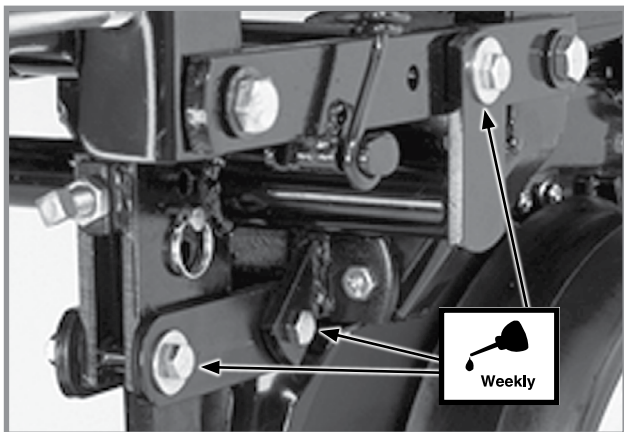

**Row Unit Mounted Disc Furrower Parallel
Linkages (6 Per Row)**

GREASE FITTINGS

Lubricate parts with grease fittings at frequency indicated with an SAE multipurpose grease. Clean fitting thoroughly before greasing. Frequency of lubrication is based on normal operating conditions. Severe or unusual conditions may require more frequent attention.

NOTE: Numbers on illustration below correspond to photos on following pages showing lubrication frequencies.

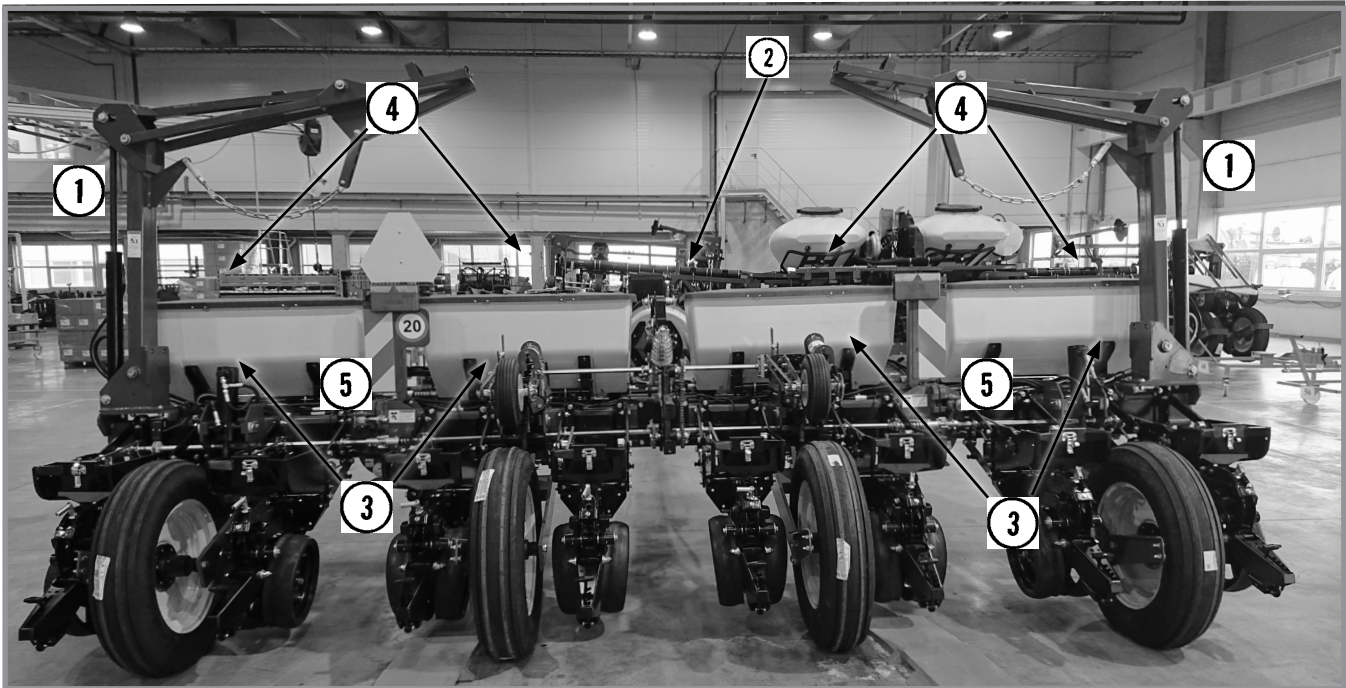

Model 3030 8 Row 70 cm Planter Shown

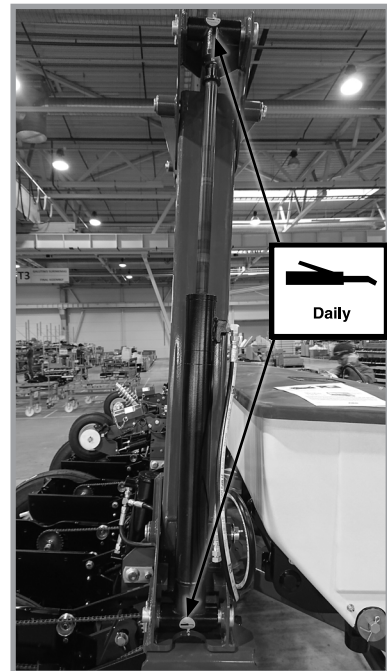
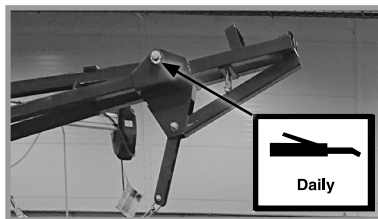
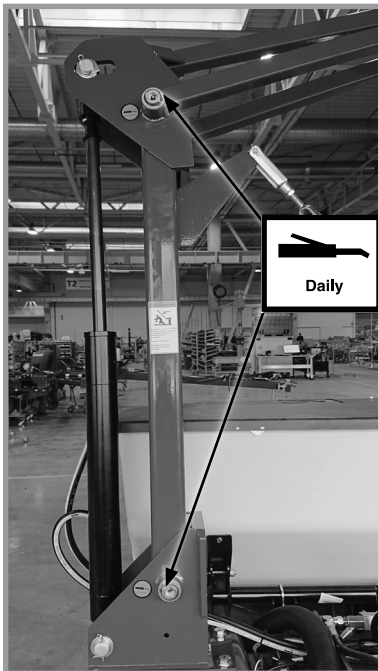

1. Row markers - 5 per marker.

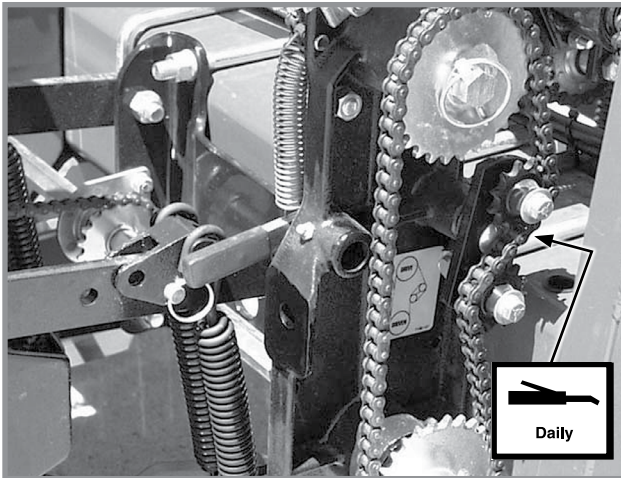

2. Seed Rate Transmission Assembly - 1 (Idler)

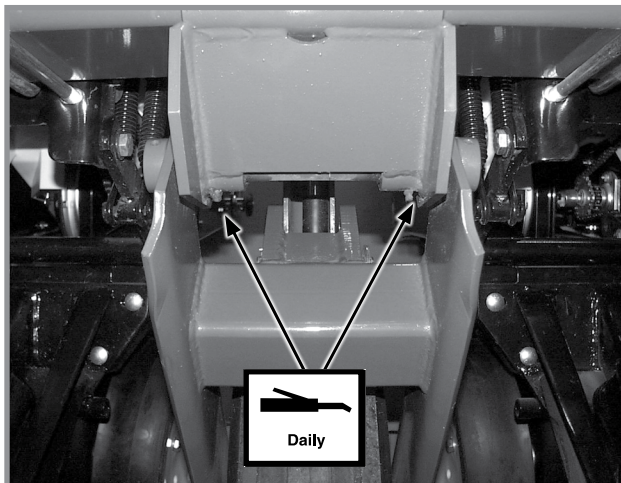

3. Wheel Module Assembly - 2 Per Module

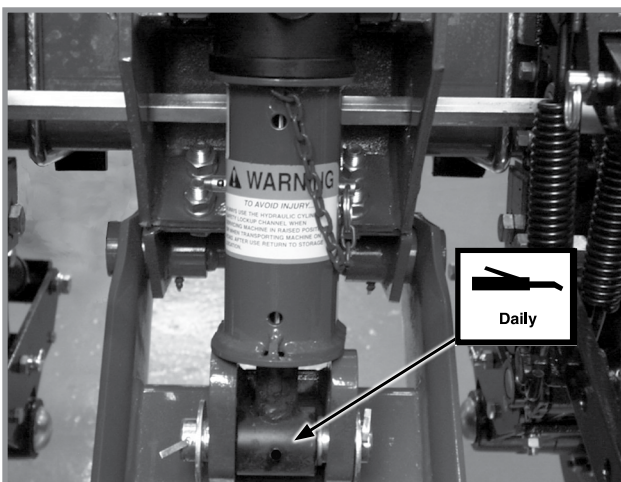

4. Lift Cylinders (Master and Slave) - 1 Per Cylinder.

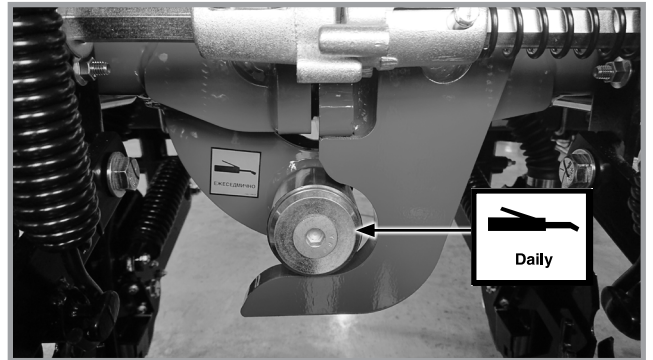

5. Frame Fold - 1 per side.

Hitch side Wing Assembly



Wing Hinges - 2 per Wing.

Fertilizer Openers

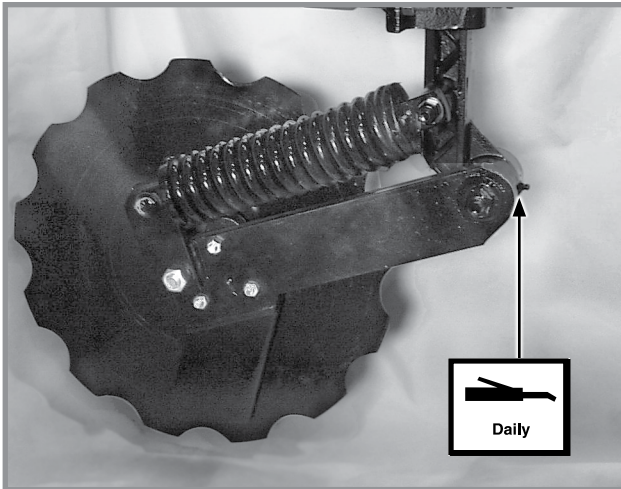

Notched Single Disc Fertilizer Opener - 1

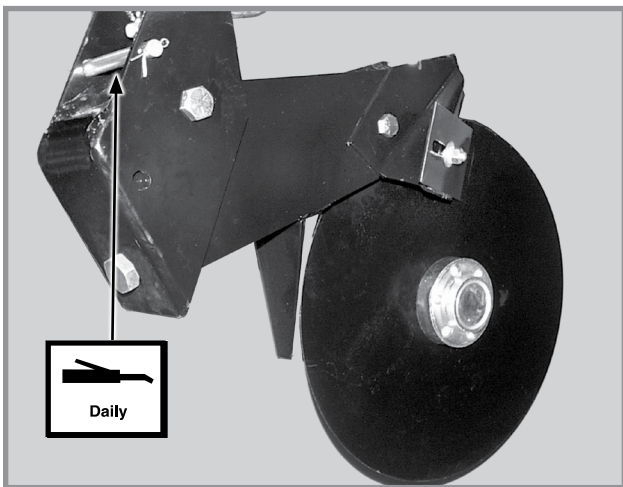

Double Disc Fertilizer Opener - 1

Row Unit

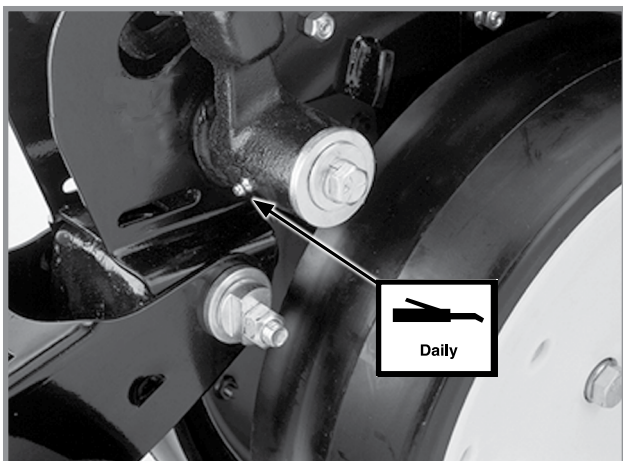

Gauge Wheel Arms - 1 Per Arm
(Seals installed with lip facing out to allow grease to purge dirt from seal. Pump grease into arm until fresh grease appears between washers and arm.)

Dry Fertilizer Attachment

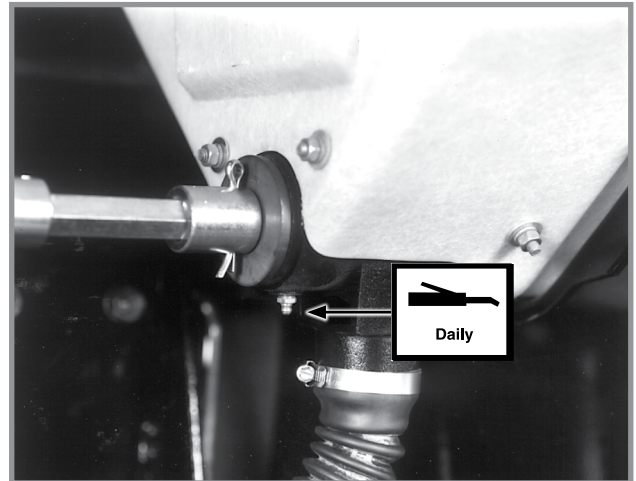

Dry Fertilizer Hopper - 2 Per Hopper

NOTE: For Dry Fertilizer Drive Chain Lubrication see ["Drive Chains" on page 6-2.](#)

MOUNTING BOLTS AND HARDWARE

Before operating planter for the first time, check all hardware is tight. Check all hardware again after first 50 hours of operation and beginning of each planting season.

All hardware used on the Kinze planter is Grade 5 (high strength) unless otherwise noted. Grade 5 cap screws are marked with three radial lines on the head. Hardware must be replaced with equal size, strength, and thread type.

WARNING





Loose transport wheel lug bolts can result in wheel separation from planter and result in death, serious injury, and damage to property and equipment. Check transport wheel lug nut torque before operating planter for the first time and periodically thereafter.

NOTICE

Over-tightening hardware can reduce its shock load capacity and cause equipment failure.

TORQUE VALUES CHART - PLATED HARDWARE

Diameter	Grade 2 (No marks) 		Grade 5 (3 marks) 		Grade 8 (6 marks) 	
	Coarse	Fine	Coarse	Fine	Coarse	Fine
1/4"	50 in-lb	56 in-lb	76 in-lb	87 in-lb	9 ft-lb (~12 Nm)	10 ft-lb (~14 Nm)
5/16"	8 ft-lb (~11 Nm)	9 ft-lb (~12 Nm)	13 ft-lb (~18 Nm)	14 ft-lb (~19 Nm)	18 ft-lb (~24 Nm)	20 ft-lb (~27 Nm)
3/8"	15 ft-lb (~20 Nm)	17 ft-lb (~23 Nm)	23 ft-lb (~31 Nm)	26 ft-lb (~35 Nm)	33 ft-lb (~45 Nm)	37 ft-lb (~50 Nm)
7/16"	25 ft-lb (~34 Nm)	27 ft-lb (~37 Nm)	37 ft-lb (~50 Nm)	41 ft-lb (~56 Nm)	52 ft-lb (~71 Nm)	58 ft-lb (~79 Nm)
1/2"	35 ft-lb (~48 Nm)	40 ft-lb (~54 Nm)	57 ft-lb (~77 Nm)	64 ft-lb (~87 Nm)	80 ft-lb (~108 Nm)	90 ft-lb (~122 Nm)
9/16"	50 ft-lb (~68 Nm)	60 ft-lb (~81 Nm)	80 ft-lb (~108 Nm)	90 ft-lb (~122 Nm)	115 ft-lb (~156 Nm)	130 ft-lb (~176 Nm)
5/8"	70 ft-lb (~95 Nm)	80 ft-lb (~108 Nm)	110 ft-lb (~149 Nm)	125 ft-lb (~169 Nm)	160 ft-lb (~217 Nm)	180 ft-lb (~244 Nm)
3/4"	130 ft-lb (~176 Nm)	145 ft-lb (~197 Nm)	200 ft-lb (~271 Nm)	220 ft-lb (~298 Nm)	280 ft-lb (~380 Nm)	315 ft-lb (~427 Nm)
7/8"	125 ft-lb (~169 Nm)	140 ft-lb (~190 Nm)	320 ft-lb (~434 Nm)	350 ft-lb (~475 Nm)	450 ft-lb (~610 Nm)	500 ft-lb (~678 Nm)
1"	190 ft-lb (~258 Nm)	205 ft-lb (~278 Nm)	480 ft-lb (~651 Nm)	530 ft-lb (~719 Nm)	675 ft-lb (~915 Nm)	750 ft-lb (~1017 Nm)
1 1/8"	265 ft-lb (~359 Nm)	300 ft-lb (~407 Nm)	600 ft-lb (~814 Nm)	670 ft-lb (~908 Nm)	960 ft-lb (~1302 Nm)	1075 ft-lb (~1458 Nm)
1 1/4"	375 ft-lb (~508 Nm)	415 ft-lb (~563 Nm)	840 ft-lb (~1139 Nm)	930 ft-lb (~1261 Nm)	1360 ft-lb (~1844 Nm)	1500 ft-lb (~2034 Nm)
1 3/8"	490 ft-lb (~664 Nm)	560 ft-lb (~759 Nm)	1100 ft-lb (~1491 Nm)	1250 ft-lb (~1695 Nm)	1780 ft-lb (~2413 Nm)	2030 ft-lb (~2752 Nm)
1 1/2"	650 ft-lb (~881 Nm)	730 ft-lb (~990 Nm)	1450 ft-lb (~1966 Nm)	1650 ft-lb (~2237 Nm)	2307 ft-lb (~3128 Nm)	2670 ft-lb (~3620 Nm)



NOTE: Torque unplated hardware and bolts with lock nuts approximately 1/3 higher than above values. Torque bolts lubricated prior to installation to 70% of value shown in chart.

5/8" No Till Coultter Spindle Bolt - 120 Ft. Lbs. (~162 Nm)

Row Unit Parallel Linkage Bushing Bolts - 130 Ft. Lbs. (~176 Nm) ([See "Bushings" on page 6-3](#)).

SPECIAL TORQUE VALUES & INSTRUCTIONS

Row unit parallel linkage bushing hardware	130 ft-lb (~176 Nm)
5/8" No till coultter spindle hardware	120 ft-lb (~162 Nm)
Transport Tire Inner Budd Nuts	315 ft-lb (~427 Nm)
Transport Tire Outer Budd Nuts	1075 ft-lb (~1458 Nm)
Row Unit Disc Opener Blade Bolt**	110 ft-lb (~149 Nm) **Left hand side is left hand thread.
5/8" - 18 Wheel Lug Nuts and Lug Bolts	200 ft-lb (~271 Nm)
9/16" - 18 Wheel Lug Nuts and Lug Bolts	125 ft-lb (~169 Nm)

 WARNING	Explosive separation of rim and tire parts can cause death or serious injury. Overinflation, rim and tire servicing, improper use of rims and tires, or worn or improperly maintained tires could result in a tire explosion.
	

To prevent tire explosion:

- Maintain proper tire pressure (see ["Initial Preparation" on page 2-1](#)). Inflating a tire above or below the recommended pressure can cause tire damage.
- Mount tires only by properly trained personnel using proper equipment.
- Replace any tire with cuts or bubbles. Replace any damaged rims. Replace missing lug bolts and nuts.
- Do not weld or heat wheel assembly. Heating increases tire pressure.

CHAIN TENSION ADJUSTMENT

Drive chains equipped with a spring loaded idler are self-adjusting. The only adjustment is to shorten chain if wear stretches chain and reduces spring tension. Check idler pivot periodically to ensure they rotate freely.

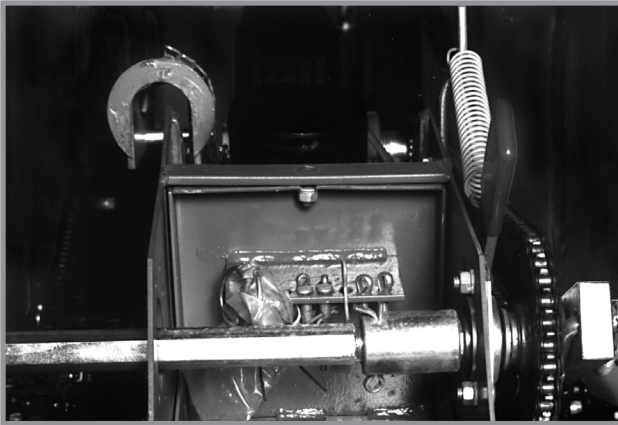

Chain link storage

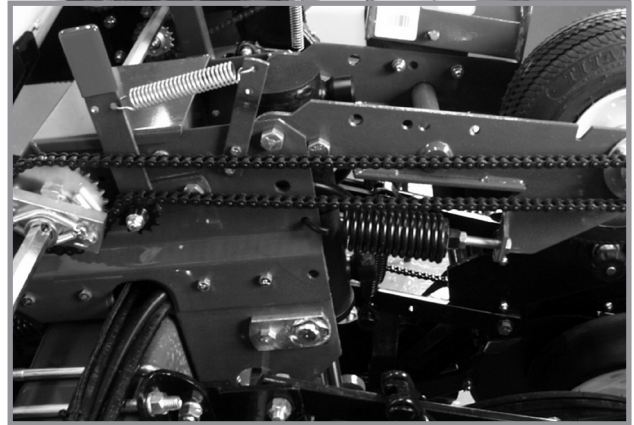

Drive chain tension adjustment

Additional chain links are in the storage box inside wheel module.

See ["Wrap Spring Wrench Lubrication" on page 6-1](#) for additional information.

FINGER PICKUP SEED METER INSPECTION/ADJUSTMENT

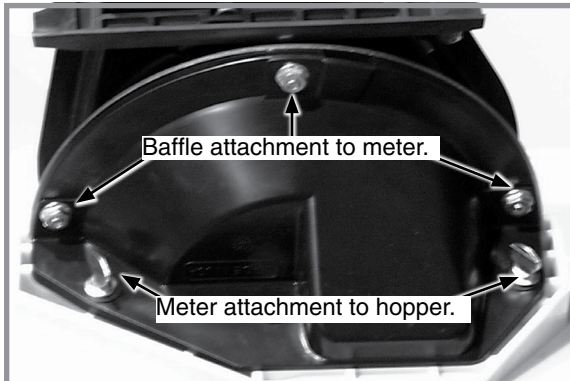

Removing meter and baffle

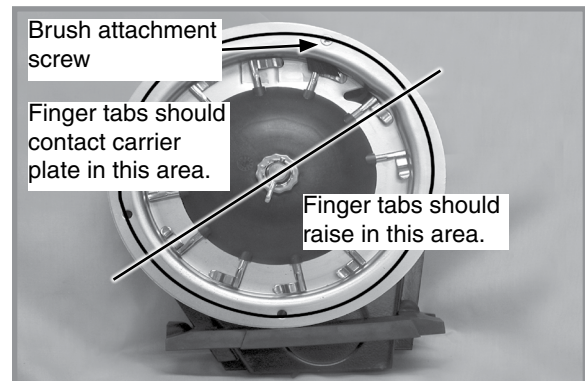

Proper finger operation

1. Remove two thumbscrews and meter from seed hopper and remove three cap screws and baffle from meter assembly.
2. Rotate seed meter drive by hand to ensure springs are holding tabs of fingers against carrier plate and fingers raise in correct area as shown in above photo.

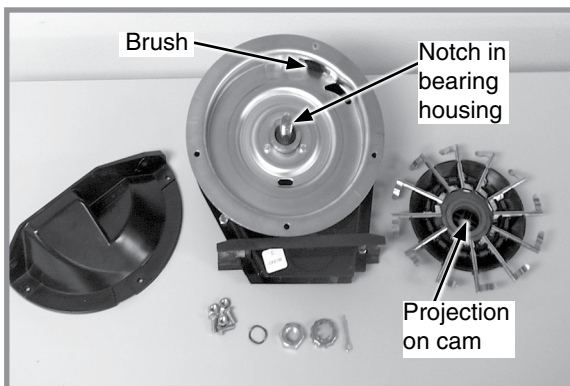

Finger pickup meter parts

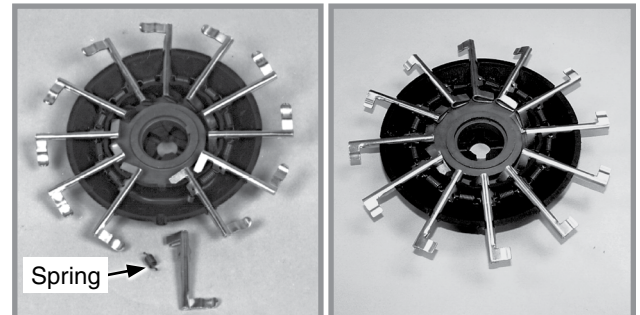

Corn Finger Assembly
(Position Spring Opening
Toward Holder)

**Oil Sunflower Finger
Assembly**

Buildup of debris or chaff may prevent proper finger operation and requires disassembly and cleaning of finger pickup meter.

1. Remove cotter pin, cover nut and adjusting nut and wave washer (If applicable) from drive shaft.
2. Carefully lift finger holder with fingers and cam off shaft and clean.
3. Check brush for wear and replace if necessary or after every 100 acres (~41 hectares) per row of operation (Approximately 800 acres (~324 hectares) of corn or sunflowers on a 8 row machine).

NOTE: It is not necessary to remove finger holder to replace brush.

4. Remove springs from fingers and remove finger from holder by lifting it out of friction fit slot. Life expectancy of these parts is about 600-900 acres (~243-364 hectares) per row of operation under average conditions.
5. Reassemble meter in reverse order after cleaning and replacing defective parts. Make sure open end of spring loop is toward inside of finger holder when replacing fingers.
6. Install fingers in holder so holder is flush with carrier plate when assembled. A cam projection aligns with a mating notch in bearing housing to ensure proper operation when assembled.

7. Check indentations on carrier plate for wear before installing finger holder on carrier plate. Excessive wear of carrier plate at indentations will cause over planting especially with small sizes of seed. Inspect carrier plate annually. Life expectancy should be 250-300 acres (~100-125 hectares) per row of operation under average conditions.
8. Install wave washer and adjusting nut with finger holder flush against carrier. Tighten adjusting nut to fully compress wave washer. Back off nut $\frac{1}{2}$ to 2 flats to obtain rolling torque of 22 to 25 inch pounds (~2,5 Nm to 2,8 Nm).
9. Turn finger holder by hand to make sure it is firmly against carrier plate, but can be rotated with moderate force.
10. Install cover nut and cotter pin. Reinstall baffle.

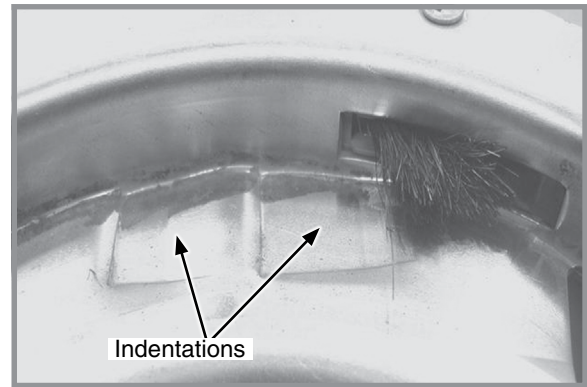

Worn carrier plate

NOTE: Check adjusting nut tightness on each unit after first day of use and periodically thereafter.

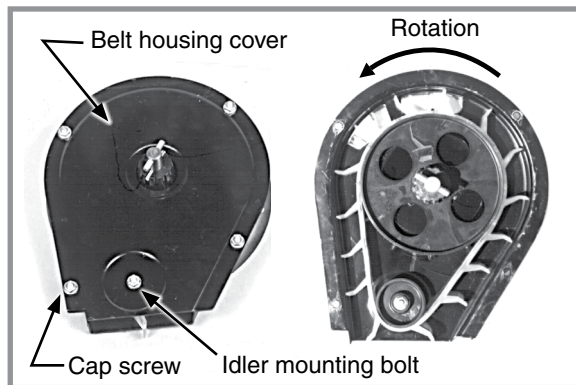

Belt idler

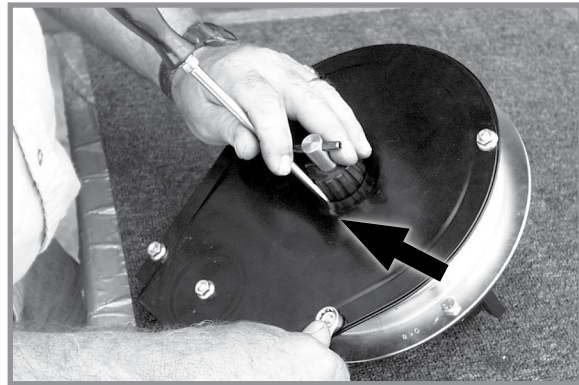

Centering belt housing cover

Remove four cap screws around edge of housing cover and nut from belt idler mounting bolt. Paddles must be correctly oriented as shown above if belt is replaced. A diagram molded into drive sprocket shows correct orientation.

NOTICE

Do not over-tighten hardware or components may be damaged.

Reinstall housing cover. **DO NOT TIGHTEN** hardware. Wedge a screwdriver between sprocket hub and housing cover as shown above. Pry cover down until centered on belt housing and tighten hardware. Rotate meter drive shaft and check idler alignment. Seed belt should “run” centered on idler or with only slight contact with belt housing or cover.

CLEANING FINGER PICKUP SEED METER FOR STORAGE

1. Disassemble meter and blow out any foreign material.
2. Wash **ONLY** in mild soap and water. Do not use gasoline, kerosene, or any other petroleum based product. Dry thoroughly.
3. Coat lightly with a rust inhibitor.
4. Rotate finger assembly so finger does not touch brush.
5. Reassemble and store in a dry, rodent-free location.

BRUSH-TYPE SEED METER MAINTENANCE

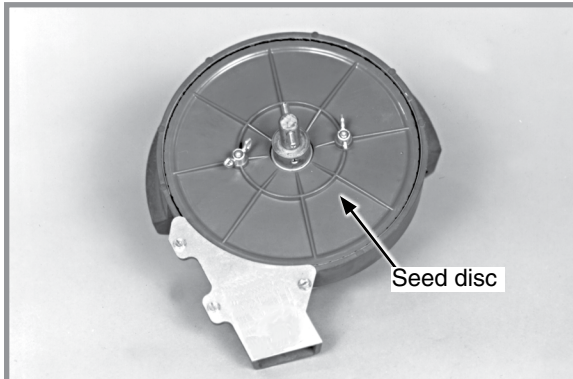

Brush-type seed meter seed disc installed

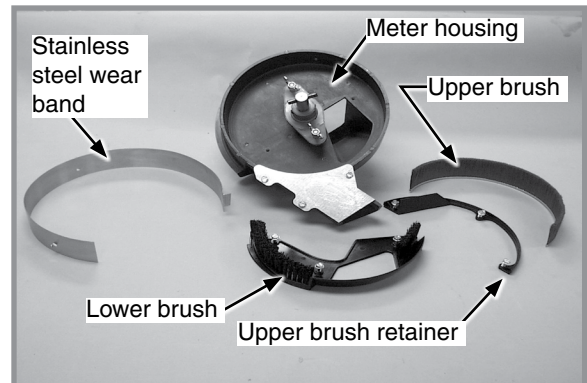

Brush-type seed meter parts

Use clean, high quality seed. Damaged or cracked seed, hulls, or foreign materials can become lodged in upper brush and greatly reduce meter accuracy. Remove seed disc daily and check for buildup of foreign material on seed disc, particularly in seed loading slots. Clean disc by washing it with soap and water. Check for cracked seed, hulls, etc. lodged between brush retainer and stainless steel wear band which can greatly reduce accuracy of the meter because upper brush will not be able to retain seed in seed disc pocket. Thoroughly clean brush areas of meter housing.

SEED DISC WEAR

Most seed disc wear is found in the agitation groove area (area between seed loading slots). Wear affects planting accuracy at high RPM. Lay a straight edge across disc surface at agitation groove area and measure gap between disc and straight edge. If agitation groove areas are worn in excess of .030" (~8 mm) and accuracy starts to drop off at higher meter RPM, replace seed disc. Estimated seed disc life expectancy under normal operating conditions is approximately 200 acres (~81 hectares) per row. Severe operating conditions such as dust, lack of lubrication or abrasive seed coating could reduce seed disc life expectancy to under 100 acres (~41 hectares) per row.

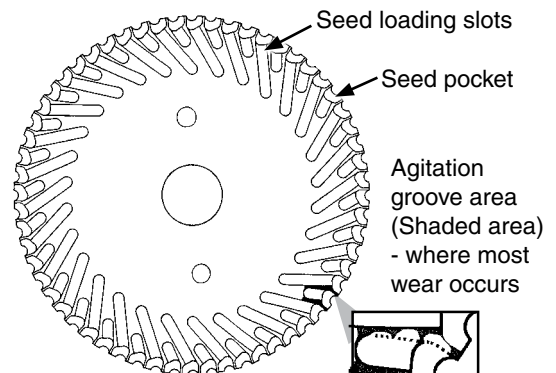

STAINLESS STEEL WEAR BAND

NOTICE	If wear band wears through or if meter is used without wear band in place, meter housing may be damaged.
---------------	---

Stainless steel wear band protects meter housing from wear and is .030" (~8 mm) thick. Replace wear band when there is approximately .020" (~0,5 mm) of wear in primary wear area. Estimated life expectancy of stainless steel wear band is 240-800 acres (~97-324 hectares) per row.

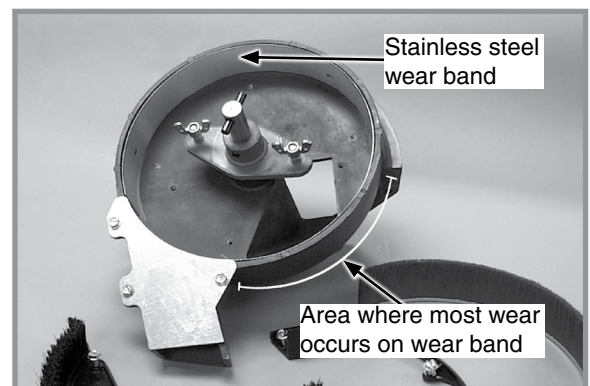

Stainless steel wear band

UPPER BRUSH

Upper brush holds seed in seed disc pocket in seed retention area. Brush must apply enough pressure against seed in seed disc pocket as disc rotates through seed retention area to prevent seed from dropping out of disc pocket. A damaged spot, excessive brush wear, or foreign material lodged in brush may greatly reduce meter performance.

Replace upper brush at 120-400 acres (~49-162 hectares) per row of use or sooner if damage or excessive wear is found. Position upper brush into inner perimeter of seed retention area. Make sure base of brush is tight against bottom of meter housing. Install brush retainer and three hex head screws. Tighten screws in sequence shown in photo at right.

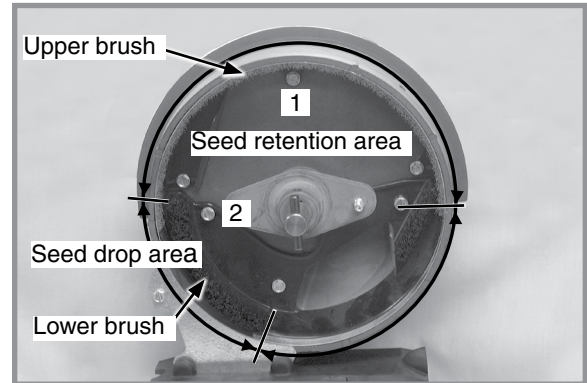

Upper brush installation

NOTE: Use GD11122 upper brush retainer for soybean and cotton discs. Use GD8237 upper brush retainer for milo/grain sorghum discs.

LOWER BRUSH

Lower brush moves seed down seed loading slots to seed pockets, isolates seed in reservoir from entering seed tube, and cleans seed loading slots. Estimated lower brush life expectancy is 240-800 acres (~97-324 hectares) per row. Replace lower brush if bristles are deformed or missing, or if there are cracks in brush retainer.

CLEANING BRUSH-TYPE SEED METER FOR STORAGE

1. Remove meter from seed hopper by removing two thumbscrews securing meter to hopper.
2. Remove seed disc and wash with soap and water and dry thoroughly.
3. Remove three hex head screws from brush retainer. Remove brush retainer and upper brush.
4. Remove three hex head screws from lower brush. Remove lower brush and stainless steel wear band.
5. Wash all parts and meter housing with soap and water and dry thoroughly.
6. Inspect all parts and replace worn parts.
7. Reassemble meter except for seed disc. Store meter in a dry, rodent-free space with seed disc removed.

This page left blank intentionally.

VACUUM SEED METER MAINTENANCE

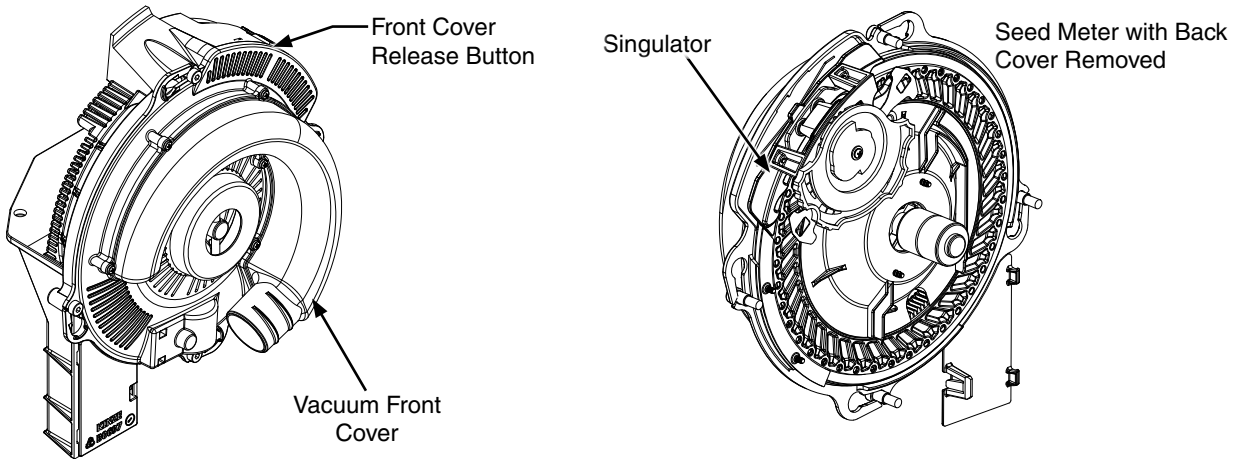

Before each planting season inspect seed discs and singulator and clean or replace as needed.

Use clean, high quality seed for maximum meter accuracy. Damaged or cracked seed, hulls, and foreign material may become lodged in seed disc orifices and greatly reduce meter accuracy.

Inspect and clean seed discs daily checking for any buildup of foreign material and blocked orifices. If seed disc orifices are plugged frequently with seed remnants, remnants ejector wheel may need to be replaced. Clean seed disc by washing it with soap and water. Dry thoroughly.

Inspect singulator blades and guide for wear after every 200 acres (~81 hectares) per row of operation. If adjustment of singulator blade does not affect meter performance or if blades appear worn, singulator blade may need to be replaced.

Replace seed disc or vacuum seal if abnormally high vacuum is required or if consistent operation cannot be achieved.

See "[Vacuum Settings](#)" on page 3-5 for additional Vacuum Seed Metering System maintenance.

NOTE: Remove seed discs from meters for annual storage and store them vertically on a dowel or pipe.

SEED METER CLEANOUT

NOTE: Use of damaged seed or seed containing foreign material will cause plugging of seed cell orifices and require more frequent seed meter cleanout to prevent underplanting.

Thorough seed meter cleanout is important to maintain genetic purity.

1. Disengage seed drive and remove seed hopper and meter.
2. Dump seed from right rear corner of hopper into a container.
3. Lay hopper on its right side. Push release button and rotate seed meter vacuum cover clockwise to align keyhole slots with bolt heads. Lift off cover.
4. Rotate seed disc hub clockwise to unlock and remove seed disc.
5. Empty meter.
6. Thoroughly inspect meter to ensure all seed is removed.
7. Replace seed disc. Install vacuum cover.

GAUGE WHEEL ADJUSTMENT

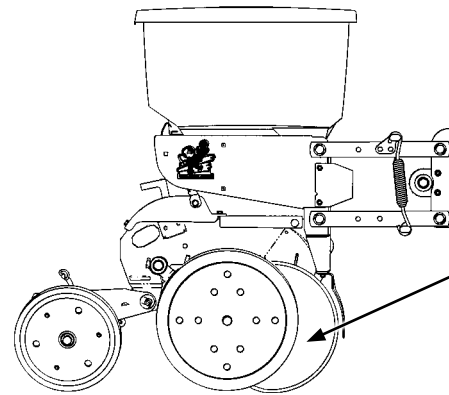
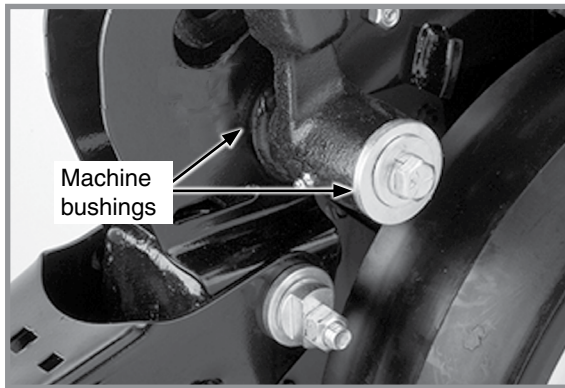

Gauge wheel adjustment

Gauge wheels should lightly contact opener blades to prevent accumulation of dirt or trash. Gauge wheels and opener blades should turn with only slight resistance.

Add or remove machine bushings between shank and gauge wheel arm to adjust clearance between gauge wheels and opener blades. Store remaining machine bushings between gauge wheel arm and flat washer on outer side of gauge wheel arm.

NOTE: It may be desirable to space gauge wheel further from blade when operating in sticky soils.

GAUGE WHEEL ARM BUSHING AND/OR SEAL REPLACEMENT

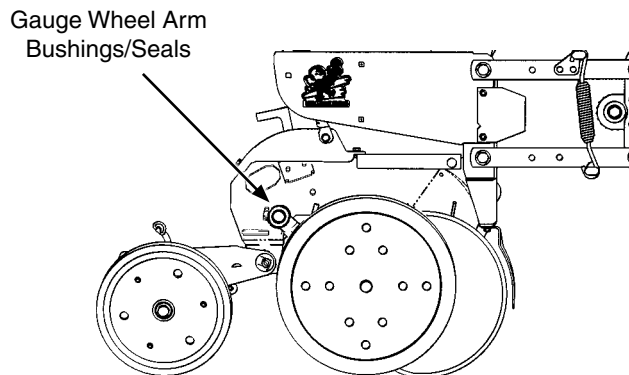

NOTE: Gauge Wheel Arm Bushing and Seal Driver Kit (G1K296) is available through your Kinze Dealer.

1. Remove gauge wheel from arm.
2. Remove gauge wheel arm from shank assembly.
3. Remove seal and bushing and discard. Clean and dry inner bore.

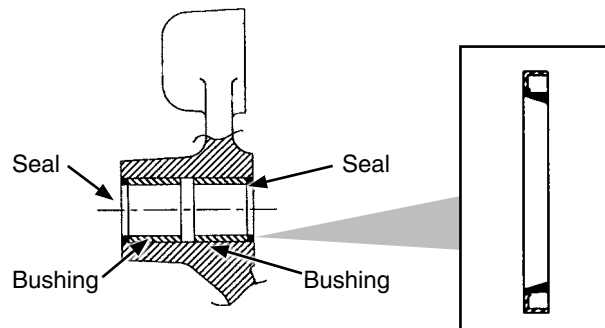

4. Drive/press replacement bushing inside bore of arm to a depth of .125" (~3,2 mm) below flush.
5. Coat wiping edge of seal with grease.
6. Drive/press seal into place with lip to outside.

NOTE: Use extra care to protect the sealing lip during installation. Apply uniform pressure to assemble the seal into the bore of the arm. Never apply a direct hammer blow to the seal surface.

7. Inspect gauge wheel pivot spindle.
8. Reinstall gauge wheel arm assembly and gauge wheel.

NOTE: Use special machine bushing between gauge wheel arm and gauge wheel.

9. Shim for proper gauge wheel tire/disc blade clearance.
10. Lubricate with an SAE multipurpose grease.

GAUGE WHEEL ARM PIVOT SPINDLE REPLACEMENT

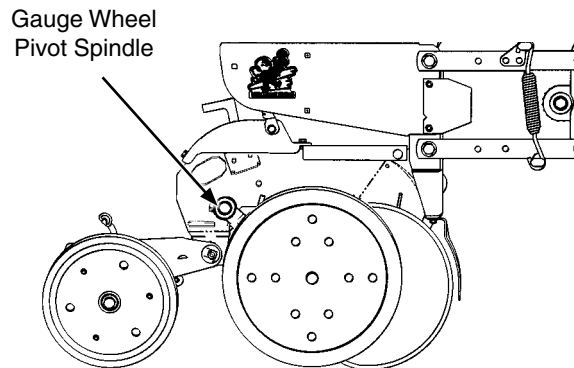

1. Remove gauge wheel and arm assemblies from shank assembly.
2. Remove $\frac{1}{2}$ " x $\frac{3}{4}$ " cap screw that locks pivot spindle in place and remove spindle.

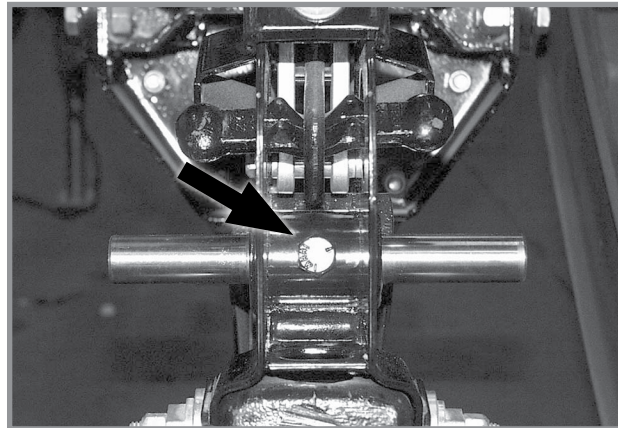

3. Install replacement spindle and position as shown below. Exact centering is critical.

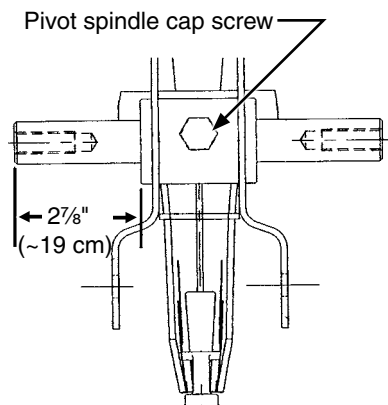

4. Install $\frac{1}{2}$ " x $\frac{3}{4}$ " cap screw and torque to lock pivot spindle in place.
5. Install gauge wheel and arm assemblies. Shim for proper gauge wheel tire/disc blade clearance.

15" SEED OPENER DISC BLADE/BEARING ASSEMBLY

NOTICE

Excessive blade contact may result in premature disc opener bearing/hub failures and excessive wear on seed tube guard/inner scraper. When properly adjusted, if one blade is held in fixed position, opposite blade should rotate with less than 5 pounds (~22 N) force at outer edge of blade.

Maintain approximately $1" \pm \frac{1}{2}"$ (~2.5 ± 1 cm) of blade-to-blade contact to properly open and form seed trench. As blade diameter decreases due to wear, it is necessary to relocate machine bushings from inside to outside to maintain $1" \pm \frac{1}{2}"$ (~2,5 ± 1 cm) of contact.

NOTE: Proper blade clearance is critical. Blades should have $1" \pm \frac{1}{2}"$ (~2,5 ± 0,5 cm) contact in this area. When blades are turned by hand in opposite directions against each other, there should be only light resistance to turning. Re-adjust blade scraper if necessary to center it between the blades.

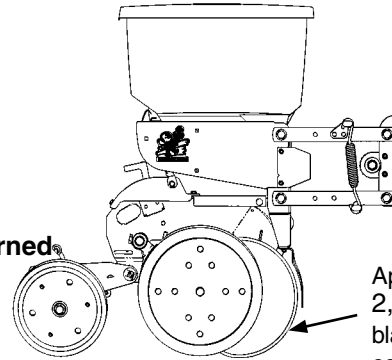

Approximately
 $2,5 \text{ cm} \pm 1 \text{ cm}$
blade-to-blade
contact.

NOTE: Replace blades if proper blade-to-blade contact cannot be maintained after relocating machine bushings or if blade diameter wears below $14\frac{1}{2}"$ (~37 cm).

Continue on the next page.

REPLACE DISC BLADE/BEARING ASSEMBLY

NOTE: Only bearing may need to be replaced if there is excessive endplay or if bearing sounds or feels rough when disc blade is rotated.

1. Remove gauge wheel, scraper, and bearing dust cap.
2. Remove cap screw, washer and disc blade/bearing assembly. Machine bushings between shank and disc blade are used to maintain approximate $1" \pm \frac{1}{2}"$ ($\sim 2,5 \pm 1$ cm) of blade-to-blade contact.

NOTICE

Left hand side of opener uses a left hand threaded cap screw. **DO NOT OVER TIGHTEN.** Damage to shank threads require replacement of row unit shank assembly.

3. Install machine bushing(s), new disc blade bearing assembly, washer and cap screw. Torque $\frac{5}{8}"$ -11 Grade 5 cap screw to 110 ft-lb (~ 149 Nm).

NOTE: Replace disc blades only with disc blades of equal thickness.

4. Install bearing dust cap, scraper, and gauge wheel.

REPLACE BEARING ONLY

1. Remove gauge wheel, scraper, bearing cap, cap screw, washer and disc blade/bearing assembly.
2. Remove $\frac{1}{4}"$ rivets from bearing housing to expose bearing.
3. Installing new bearing. install three evenly spaced $\frac{1}{4}"$ cap screws into three of six holes in bearing housing to hold bearing and bearing housing in place. Install rivets in other three holes. Remove $\frac{1}{4}"$ cap screws and install rivets in those three holes.
4. Reinstall disc blade/bearing assembly, washer and cap screw. Torque $\frac{5}{8}"$ -11 cap screw to 110 ft-lb (~ 149 Nm).
5. Install bearing dust cap, scraper, and gauge wheel.

SEED TUBE GUARD/INNER SCRAPER

Seed tube guard protects seed tube and acts as inner scraper for seed opener disc blades.

Remove seed tube and check for wear. Excessive wear on seed tube indicates a worn seed tube guard. Replace seed tube guard if it measures $\frac{5}{8}$ " (~2 cm) or less at lower end. A new seed tube guard measures approximately $\frac{7}{8}$ " (~2 cm).

NOTE: No till planting or planting in hard ground conditions, especially when planter is not equipped with no till coulters, and/or excessive blade-to-blade contact increases seed tube guard wear and requires more frequent inspection and/or replacement.

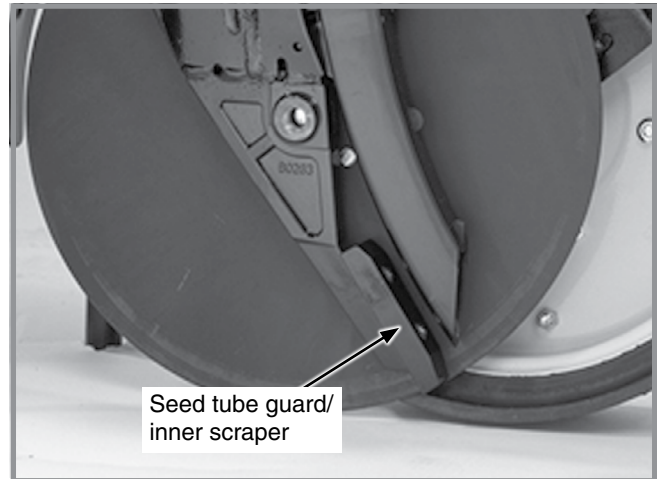

Shown with gauge wheel and seed opener disc blade removed

NOTICE

Over tightening hex socket head cap screws may damage shank threads and require replacement of shank. An excessively worn seed tube guard may allow blades to wear into row unit shank, also requiring replacement of shank.

Remove seed tube and two hex socket head cap screws that attach seed tube guard. Hold replacement seed tube guard centered between seed opener disc blades. Install hex socket head cap screws. DO NOT TIGHTEN. Using a clamp or vise-grip, squeeze opener blades together in front of seed tube guard. Tighten seed tube guard retaining screws. Remove clamps. Distance between seed tube guard and opener blades should be equal on both sides. Reinstall seed tube.

ROW UNIT MOUNTED RESIDUE WHEEL

Wheel hub is equipped with sealed bearings. If a bearing sounds or feels rough when wheel is rotated, replace them.

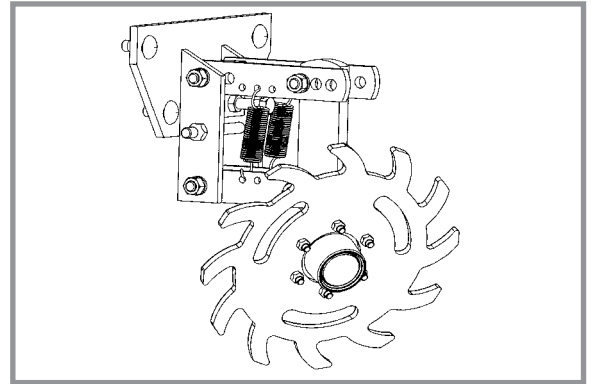

Row unit mounted residue wheels

ROW UNIT MOUNTED NO TILL COULTER

Check nuts and hardware periodically for proper torque. Be sure coulters are positioned square with row unit and aligned in front of row unit disc opener.

NOTE: Torque $\frac{5}{8}$ " spindle hardware to 120 ft-lb (~162 Nm).

Coulter blade can be adjusted to one of four settings. Initially blade is set in highest position. As blade wears it can be adjusted to one of three lower settings. See ["Row Unit Mounted No Till Coulter" on page 3-16](#).

Replace 16" (~41 cm) diameter coulters when worn to 14½" (~37 cm).



Row unit mounted no till coulters

COULTER MOUNTED RESIDUE WHEELS

Wheel hubs are equipped with sealed bearings. If bearings sound or feel rough when wheel is rotated, replace them.



Coulter mounted residue wheels

SPIKED CLOSING WHEEL

Inner parts of spiked closing wheel will begin to wear at approximately 70% of life. Flip/reverse wheel to utilize remaining life of wheel.

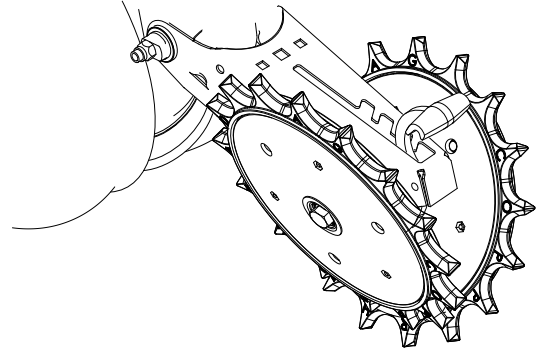

Row Unit Spiked Closing Wheel

GRANULAR CHEMICAL ATTACHMENT

Before storing planter, disengage granular chemical drive by rotating throwout knob ¼ turn counterclockwise. Remove drive chain and empty and clean all granular chemical hoppers. Clean drive chains and coat them with a rust preventive spray or submerge chains in oil. Inspect and replace worn or broken parts.

Install hoppers and chains. Check chain alignment.

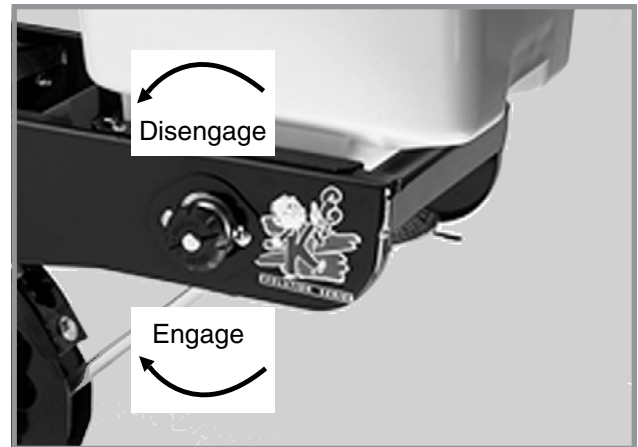

ROW MARKER SEQUENCING/FLOW CONTROL VALVE INSPECTION

WARNING

Pressurized hydraulic fluid can penetrate body tissue and result in death, serious infection, or other injuries. Fluid injected under skin must be **IMMEDIATELY** removed by a surgeon familiar with this type of injury. Make sure connections are tight and hoses and fittings are not damaged before applying system pressure. Leaks can be invisible. Keep away from suspected leaks. Relieve pressure before searching for leaks or performing any system maintenance.



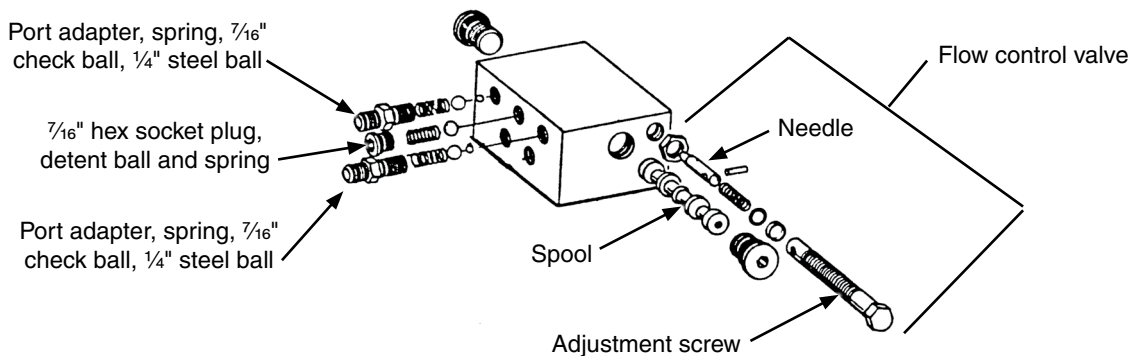

The valve block assembly consists of the row marker sequencing and flow control valves in one assembly. Sequencing valve portion consists of a chambered body containing a spool and series of check valves to direct hydraulic oil flow.

1. Remove valve block assembly from planter.
2. Remove detent assembly and port adapter assemblies from rear of valve block.

NOTICE

Damage to spool may occur if detent assembly and port adapter assemblies are not removed prior to removal of spool.

3. Remove plug from both sides of valve block and remove spool.
4. Inspect all parts for pitting, contamination, or foreign material. Check seating surfaces inside valve. Replace defective parts.
5. Lubricate spool with a light oil and reinstall. Check spool moves freely in valve body.

NOTE: Make sure correct check ball(s) and spring are installed in each valve bore upon reassembly.

A flow control valve is located on each side of block assembly. Adjust flow control valves for raise and lower speed as part of assembly procedure or upon initial operation. If valve fails to function properly or requires frequent adjustment, remove needle valve for inspection. Check for foreign material and contamination. Make sure needle moves freely in adjustment screw. Replace defective components.

NOTE: Hydraulics operate slowly when oil is cold. Make all adjustments with warm oil.

ROW MARKER BEARING LUBRICATION OR REPLACEMENT

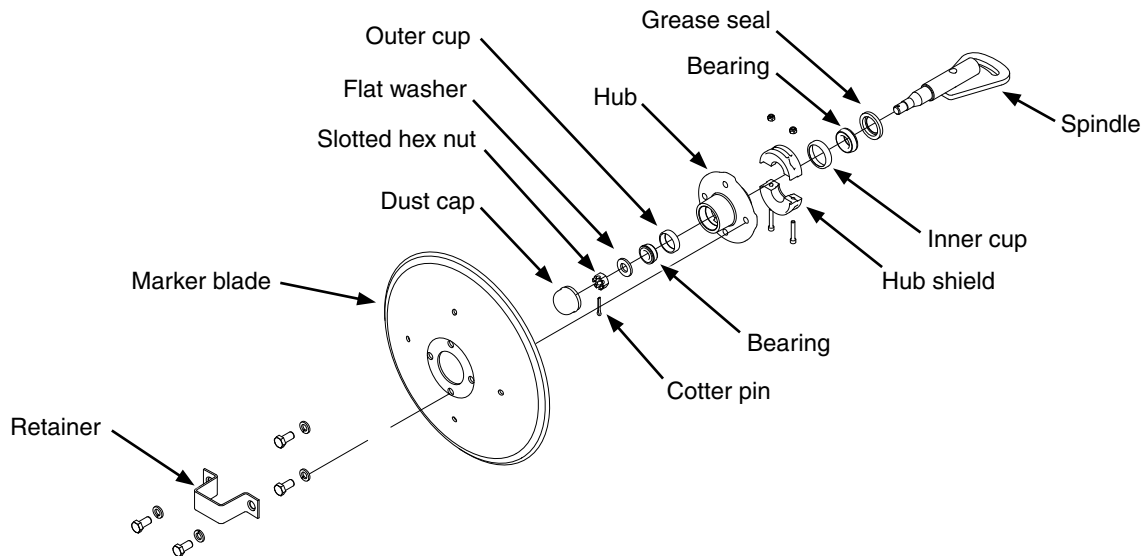

1. Remove retainer and marker blade.
2. Remove dust cap from hub.
2. Remove hub shield. Note direction of installation.
3. Remove cotter pin, slotted hex nut, and washer.
4. Slide hub from spindle.
5. Remove bearings and cups and discard if bearings are being replaced. Clean hub and dry. Remove bearings only and not cups if repacking.
6. Press in new bearing cups with thickest edge facing in. (Bearing replacement procedure only.)
7. Pack bearings with heavy duty wheel bearing grease thoroughly forcing grease between roller cone and bearing cage. Fill the space between the bearing cups in the hub with grease.
8. Install rubber seal into grease seal. Place inner bearing in place and press in new rubber seal/grease seal.
9. Clean spindle and install hub.
10. Install outer bearing, washer and slotted hex nut. Tighten slotted hex nut while rotating hub until there is some drag. This ensures all bearing surfaces are in contact. Back off slotted nut to nearest locking slot and install cotter pin.
11. Fill dust caps approximately $\frac{3}{4}$ full of wheel bearing grease and install on hub.
12. Install hub shield.
13. Install marker blade and retainer on hub. Tighten hardware evenly.

WHEEL BEARING REPACK OR REPLACEMENT

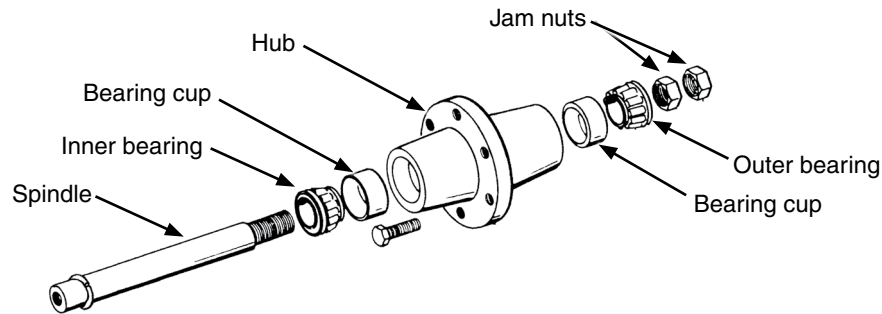

1. Raise tire clear of ground and remove wheel.
2. Remove double jam nuts and slide hub from spindle.
3. Remove bearings and cups and discard if bearings are being replaced. Clean hub and dry. Remove bearings only and not cups if repacking.
4. Press in new bearing cups with thickest edge facing in. (Bearing replacement procedure only.)
5. Pack bearings with heavy duty wheel bearing grease thoroughly forcing grease between roller cone and bearing cage. Fill space between bearing cups and hub with grease.
6. Place inner bearing in place.
7. Clean spindle and install hub.
8. Install outer bearing and jam nut. Tighten jam nut while rotating hub until there is some drag. This ensures all bearing surfaces are in contact. Back off jam nut $\frac{1}{4}$ turn or until there is only slight drag when rotating hub. Install second jam nut to lock against first.
9. Install wheel on hub. Tighten hardware evenly.

VACUUM CHECK VALVE INSPECTION (In valve block below vacuum fan motor assembly)

Check valve return prevents reverse operation of vacuum fan motor. Remove and check for foreign material or if O-ring is leaking internally. Clean or replace if defective.

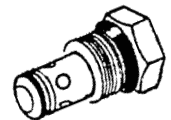

VACUUM RELIEF VALVE CARTRIDGE INSPECTION (In valve block below vacuum fan motor assembly)

NOTICE

Connect hydraulic motor case drain to a case drain return line with zero pressure on tractor or hydraulic motor will be damaged. DO NOT connect hydraulic motor case drain to SCV outlet. Contact tractor manufacturer for specific details on "zero pressure return".



Pressure relief valve helps prevent damage to vacuum fan motor by limiting pressure in motor case drain line. It is set to open at 2.4 bar (35 PSI). Remove and check for foreign material and contamination on valve or seating area of valve body. Clean or replace if defective.

PREPARING PLANTER FOR STORAGE

- Store planter in a dry sheltered area if possible. Refer to “Safety Lockups” in Machine Operation section for proper safety lockup installation during storage.
- Remove all trash that may be wrapped on sprockets or shafts and remove dirt that can draw and hold moisture.
- Clean all drive chains and coat with a rust preventative spray, or remove chains and submerge in oil.
- Lubricate planter and row units at all lubrication points.
- Inspect planter for parts that are in need of replacement and order during “off” season.
- Make sure seed and granular chemical hoppers are empty and clean.
- Remove seed discs from seed meters, clean and store meters in a rodent-free, dry area with discs removed. Store seed discs vertically on a dowel or pipe.
- Remove seed discs from brush-type seed meters, clean and store meters with discs removed.
- Remove vacuum hose from each seed meter. Operate vacuum fan at full hydraulic flow from tractor for two minutes to clear manifolds, hoses and fittings of dust and debris.
- Clean breather on analog vacuum and pressure gauges.
- Grease or paint disc openers/blades and row marker disc blades to prevent rust.
- Empty and clean dry fertilizer hoppers. Disassemble and clean metering augers. Reassemble and coat all metal parts with rust preventative.

ELECTRICAL WIRING DIAGRAM FOR LIGHT PACKAGE

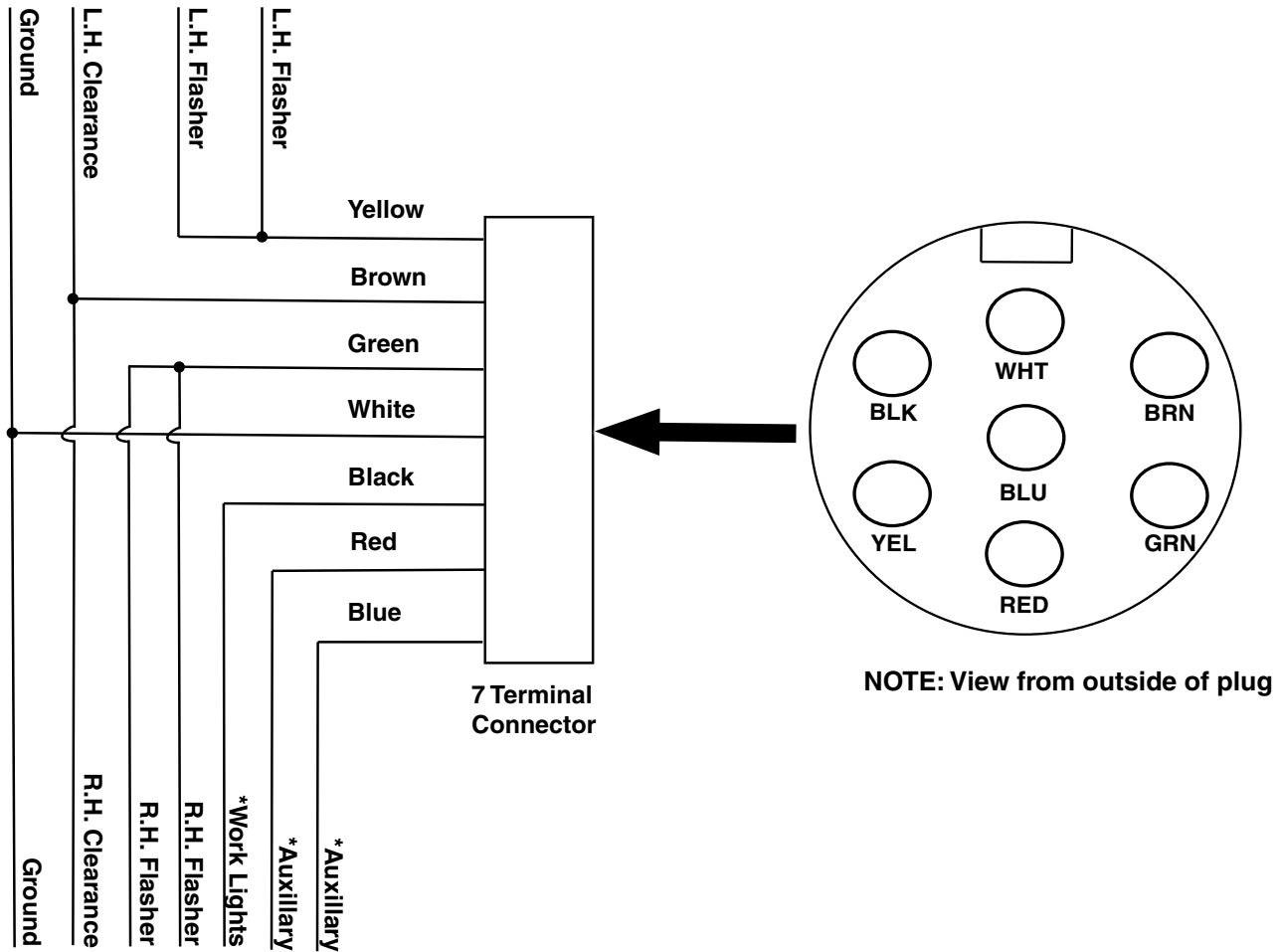

* Optional customer-supplied auxiliary lights and wires may be wired into existing plug terminals.

Continued on next page.

Light package supplied on Model 3030 planter meets ASABE Standards. For correct wiring harness to be wired into lights on your tractor, check with tractor manufacturer.

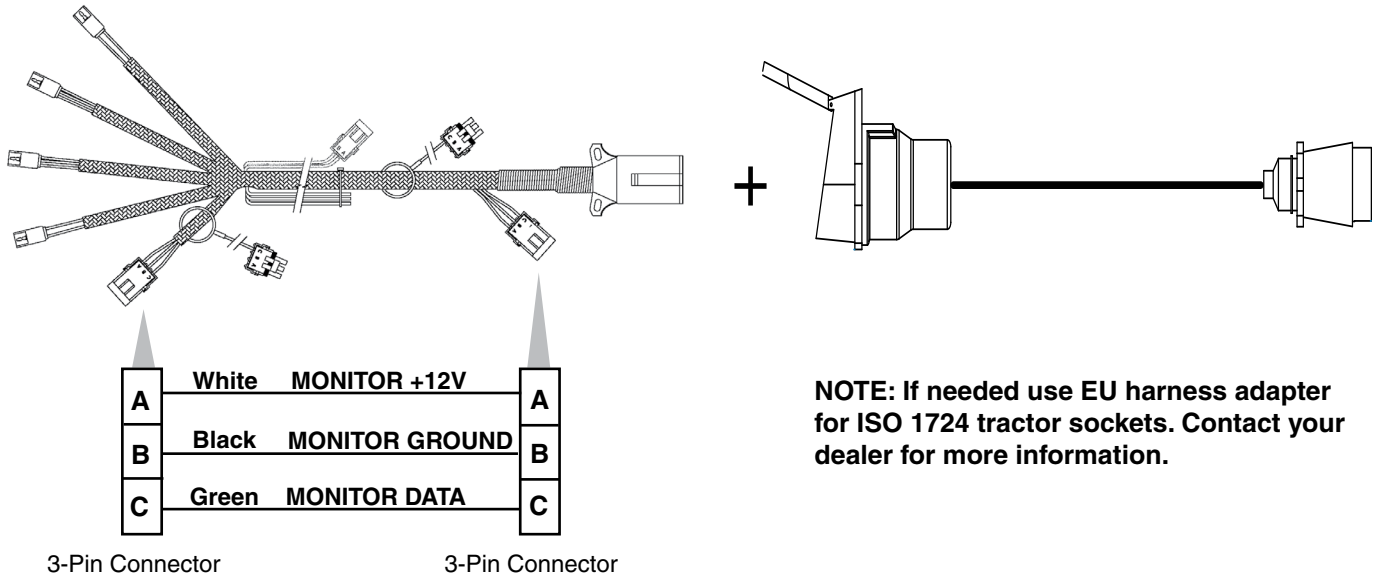

EU HARNESS ADAPTER DIAGRAM (ISO 1724)

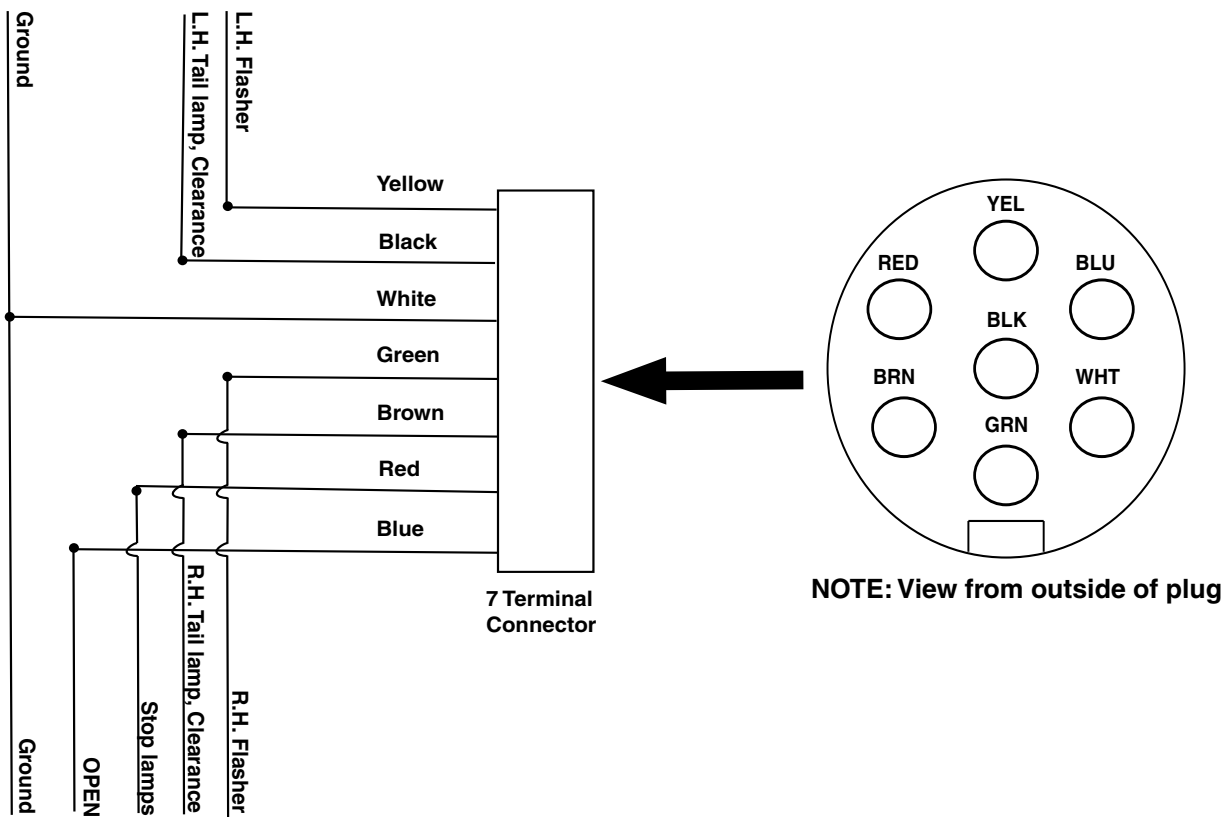

HYDRAULIC HOSE LIFE

**WARNING**

Pressurized hydraulic fluid can penetrate body tissue and result in death, serious infection, or other injuries. Fluid injected under skin must be **IMMEDIATELY** removed by a surgeon familiar with this type of injury. Make sure connections are tight and hoses and fittings are not damaged before applying system pressure. Leaks can be invisible. Keep away from suspected leaks. Relieve pressure before searching for leaks or performing any system maintenance.



Proper storage of hydraulic hoses can significantly increase the life of the hoses, for a period of three to five years. After this period, service life of hoses may decrease, depending on variables such as variances in rubber materials and storage environment. Refer to the guidelines below for best practices when storing.

- Store in a clean, cool and dry area
- Avoid direct sunlight or moisture
- Do not store near high power electrical equipment
- Avoid contact with corrosive chemicals
- Avoid ultraviolet light
- Avoid areas with obvious signs of insects or rodents

Unusually long periods of storage or poor storage environment may lead to performance issues or premature failure. Always inspect all hoses prior to use for extensive wear, cuts, or holes. If such flaws are identified, replace immediately to avoid potential failure, property damage or bodily injury.

NOTE: Planters in EU market must be used with harness adapter- GA25321.

HYDRAULIC SYSTEM SCHEMATIC

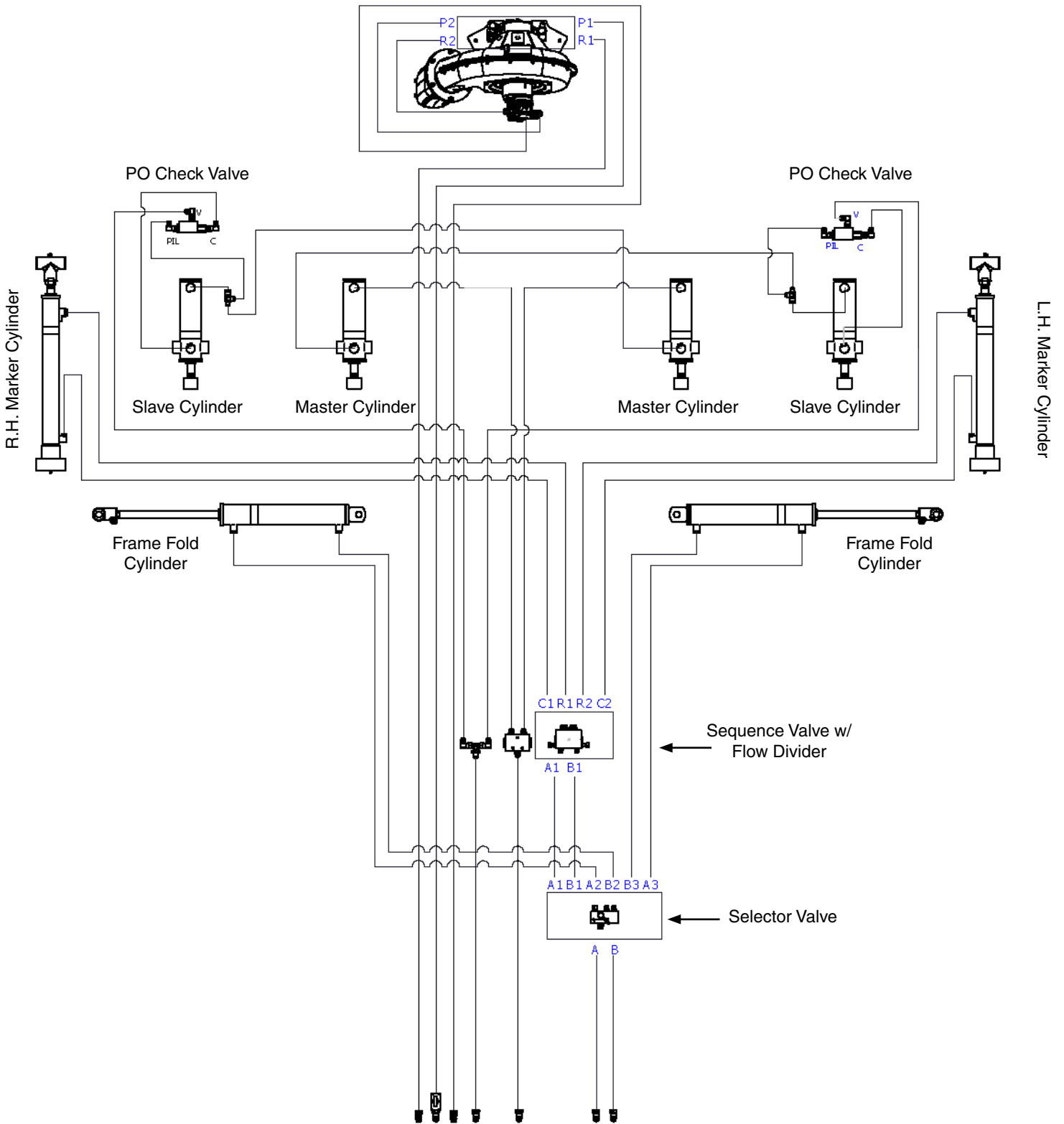

HYDRAULIC SCHEMATIC - VACUUM FAN MOTOR SYSTEM

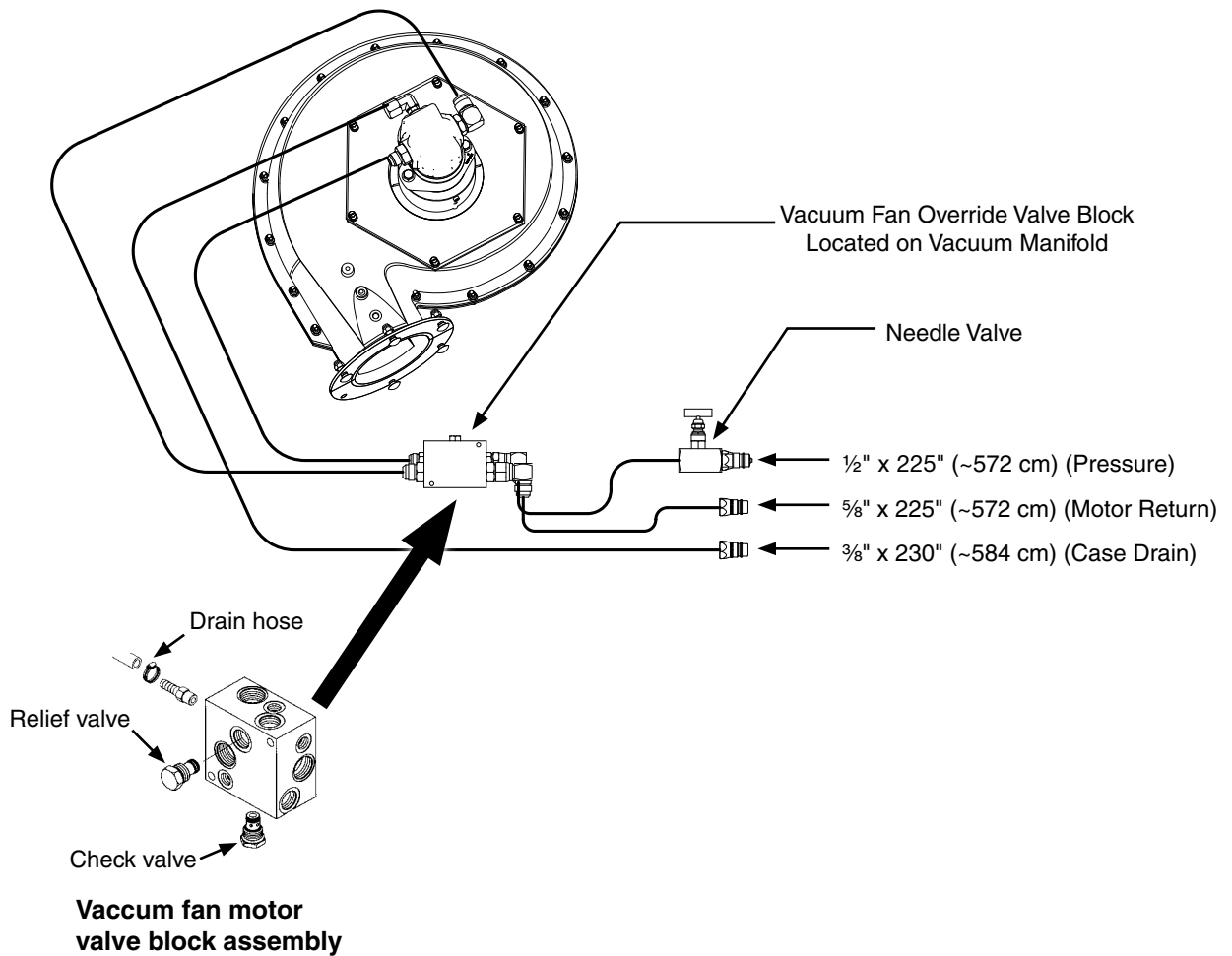

NOTICE	<p>Failure to connect to a return with zero pressure will damage hydraulic motor. Connect hydraulic motor case drain to a case drain return line with zero pressure on tractor. DO NOT connect hydraulic motor case drain to SCV outlet. Contact tractor manufacturer for specific details on "zero pressure return".</p>
---------------	--

This page left blank intentionally.

CLOSING WHEEL TROUBLESHOOTING

PROBLEM	POSSIBLE CAUSE	SOLUTION
Closing wheel(s) leave severe imprint in soil.	Too much closing wheel down pressure.	Adjust closing wheel pressure.
Closing wheel(s) not firming soil around seed.	Insufficient closing wheel down pressure.	Adjust closing wheel pressure. Severe no till conditions may require use of cast iron closing wheels.
“V” closing wheel running on top of seed furrow.	Improper centering.	Align. See “V Closing Wheel Adjustment”.
Single closing wheel not directly over seed.	Improper centering.	Align. See “Covering Discs/Single Press Wheel Adjustment”.

LIFT CIRCUIT OPERATION TROUBLESHOOTING

PROBLEM	POSSIBLE CAUSE	TROUBLESHOOTING*	SOLUTION
Planter raising uneven.	Master cylinder leaking.	Raise planter slowly until master cylinder reaches end of stroke. If master cylinder is leaking it will lag behind the slave cylinder, causing the tire to squat less. If planter settles when hydraulic lever is released, check assist cylinders.	Check piston rephasing valve for contamination. Before removing rephasing valve, measure set screw setting by turning set screw clockwise and counting the revolutions until it bottoms out. After cleaning rephasing valve, bottom the screw out and back it out the same number of revolutions as the original setting. Replace rephasing valve and adjust as stated above or replace piston. Install seal kit. Consult your Kinze Dealer for leak testing and rephasing valve adjustment if necessary.
	Slave cylinder leaking.	Raise and lower planter. As planter lowers, side with leaking slave cylinder will drop rapidly. Install wheel lockups on master and assist cylinders. Retract slave cylinder and observe which tire settles. If planter settles when hydraulic lever is released, check assist cylinders.	Check piston rephasing valve for contamination. Prior to removing rephasing valve, measure the set screw setting by turning the set screw clockwise and counting the revolutions until it bottoms out. After cleaning rephasing valve, bottom the screw out and back it out the same number of revolutions as the original setting. Replace rephasing valve and adjust as stated above or replace piston. Install seal kit. Consult your Kinze Dealer for leak testing and rephasing valve adjustment if necessary.

*Operate hydraulics slowly to accentuate the problem. Rephase after each lowering cycle.

ROW MARKER OPERATION TROUBLESHOOTING

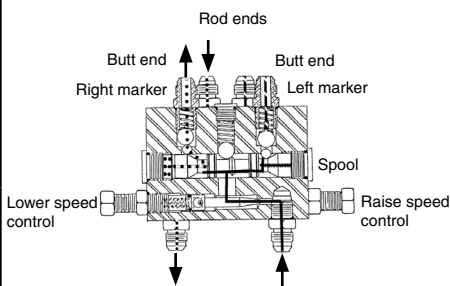
PROBLEM	POSSIBLE CAUSE	SOLUTION
Same marker always operating. 	Inadequate oil flow to sequencing valve. Most commonly associated with single valve system (lift and markers on same remote).	TEST: Raise planter and install transport lockups. Attempt to raise and lower planter. All hydraulic oil will be directed to markers. If markers function properly, the sequence valve is OK. Adjust marker speed so planter is up before marker arm is completely up.
	Spool in sequencing valve not shifting.	Remove spool. Inspect for foreign material, making sure all ports in spool are open. Clean and reinstall.
Both markers lowering and only one raising at a time.	Hoses from cylinders to valve connected backwards.	Check hosing diagram in manual and correct.
Both markers lower and raise at same time	Foreign material under check ball in sequencing valve.	Remove hose fitting, spring and balls. Clean. May be desirable to remove spool and clean as well.
	Check ball missing or installed incorrectly in sequencing valve.	Disassemble and correct. See above illustration.
Marker (in raised position) settling down.	Damaged O-ring in marker cylinder or cracked piston.	Disassemble cylinder and inspect for damage and repair.
	Spool in sequencing valve not shifting completely because detent ball or spring is missing.	Check valve assembly and install parts as needed.
	Spool in sequencing valve shifting back toward center position.	Restrict flow of hydraulic oil from tractor to sequencing valve.
Neither marker will move.	Flow control closed too far.	Loosen locking nut and turn flow control adjustment bolt out or counterclockwise until desired speed is set.
Markers moving too fast.	Flow control open too far.	Loosen locking nut and turn flow control adjustment bolt in or clockwise until desired speed is set.
Sporadic marker operation speed.	Needle sticking open in flow control valve.	Remove flow control, inspect and repair or replace.

PTO PUMP DRIVE AND OIL COOLER OPTION

PROBLEM	POSSIBLE CAUSE	SOLUTION
Pump is squealing.	Lack of oil to pump.	Check for plugged suction strainer. Check oil level.
Oil temperature is high.	Low oil level.	Check oil level and add as required.
Desired fan speed cannot be achieved.	Low oil level.	Check oil level and add as required.
	Plugged filter.	Check and change as required.

SEED METER (BRUSH-TYPE) TROUBLESHOOTING

PROBLEM	POSSIBLE CAUSE	SOLUTION
Low count.	Meter RPM too high.	Reduce planting speed.
	Seed sensor not picking up all seeds dropped.	Clean seed tube. Switch meter to different row. If problem stays with same row, replace sensor.
	Lack of lubrication causing seeds not to release from disc properly.	Use graphite or talc as recommended.
	Seed size too large for seed disc.	Switch to smaller seed or appropriate seed disc. See "Brush-Type Seed Meter" for proper seed disc for size of seed being used.
	Seed treatment buildup in meter.	Reduce amount of treatment used and/or thoroughly mix treatment with seed. Add talc.
Low count at low RPM and higher count at higher RPM.	Foreign material lodged in upper brush.	Remove seed disc and remove foreign material from between brush retainer and bristles. Clean thoroughly.
	Worn upper brush.	Replace. See "Maintenance".
Low count at higher RPM and normal count at low RPM.	Seed disc worn in the agitation groove area.	Replace disc. See "Maintenance".
High count.	Seed size too small for seed disc.	Switch to larger seed or appropriate seed disc.
	Incorrect seed rate transmission setting.	Reset transmission. Refer to proper rate chart in "Machine Operation" section of manual.
	Upper brush too wide (fanned out) for small seed size.	Replace upper brush.
High count. (Milo/Grain Sorghum)	Incorrect brush retainer.	Make sure GD8237 brush retainer is installed to keep upper brush from fanning out.
Upper brush laid back.	Seed treatment buildup on brush.	Remove brush. Wash with soap and water. Dry thoroughly before reinstalling. See "Maintenance".
	Buildup of foreign material at base of brush.	Remove brush retainer and brush. Clean thoroughly. Reinstall.

SEED METER (FINGER PICKUP) TROUBLESHOOTING

PROBLEM	POSSIBLE CAUSE	SOLUTION
One row not planting seed.	Drive release not engaged.	Engage drive release mechanism.
	Foreign material in hopper.	Clean hopper and finger carrier mechanism.
	Seed hopper empty.	Fill seed hopper.
	Row unit drive chain off of sprocket or broken.	Check drive chain.
Drive release does not engage properly.	Drive release shaft is not aligned properly with meter drive shaft.	Align drive mechanism.
Unit is skipping.	Foreign material or obstruction in meter.	Clean and inspect.
	Finger holder improperly adjusted.	Adjust to specifications. (22 to 25 in. lbs. rolling torque)
	Broken fingers.	Replace fingers and/or springs as required.
	Planting too slowly.	Increase planting speed to within recommended range.
Planting too many doubles.	Planting too fast.	Stay within recommended speed range.
	Loose finger holder.	Adjust to specifications. (22 to 25 in. lbs. rolling torque)
	Worn brush in carrier plate.	Inspect and replace if necessary.
Overplanting.	Worn carrier plate.	Inspect and replace if necessary.
	Seed hopper additive being used.	Reduce or eliminate additive or increase graphite.
Underplanting.	Seed belt installed backwards.	Remove and install correctly.
	Weak or broken springs.	Replace.
	Spring not properly installed.	Remove finger holder and correct.
	Seed belt catching or dragging.	Replace belt.
	Brush dislodging seed.	Replace brush.
Irregular or incorrect seed spacing.	Driving too fast.	Check chart for correct speed.
	Wrong tire pressure.	Inflate tires to correct air pressure.
	Drive wheels slipping.	Reduce down pressure on row unit down force springs.
	Wrong sprockets.	Check seed rate charts for correct sprocket combinations.
Seed spacing not as indicated in charts.	Wrong tire pressure.	Inflate tires to correct air pressure.
	Inconsistent seed size.	Perform field check and adjust sprockets accordingly.
	Wrong sprockets.	Check chart for correct sprocket combination.
	Charts are approximate.	Slight variations due to wear in meter components and tire slippage due to field conditions may produce seed spacing variations.
	Stiff or worn drive chains.	Replace chains.
Scattering of seeds.	Planting too fast.	Reduce planting speed.
	Seed tube improperly installed.	Check seed tube installation.
	Seed tube worn or damaged.	Replace seed tube.
Seed tubes and/or openers plugging.	Allowing planter to roll backward when lowering.	Lower planter only when tractor is moving forward.
Inconsistent seed depth.	Rough seed bed.	Adjust down pressure springs. Reduce planting speed.
	Partially plugged seed tube.	Inspect and clean.
	Seed tube improperly installed.	Install properly.

VACUUM SEED METER

PROBLEM	POSSIBLE CAUSE	SOLUTION
Low seed count.	Meter RPM too high.	Reduce planting rate or planting speed.
	Singulator blade setting too aggressive.	Adjust singulator blade.
	Vacuum level too low.	Increase fan speed.
	Seed sensor not picking up all seeds dropped.	Clean seed tube. Move meter to different row.
	Seeds sticking to seed disc.	Use graphite or talc to aid release.
	Seed treatment buildup in seed disc recesses.	Reduce amount of treatment used and or mix thoroughly. Add talc.
	Seed size too large for disc used.	Use appropriate disc for seed size.
	Wrong seed disc.	Use appropriate disc for seed type and size.
	Failed/worn drive components.	Inspect and replace parts as required.
	Plugged orifices in seed disc.	Inspect and clean disc. Check remnant ejector.
	Loss of vacuum at meter.	Check for foreign material between vacuum cover and disc. Inspect parts for wear/damage. Clean or replace as required.
	Seed bridging in hopper.	Add graphite to improve seed flow.
	Faulty vacuum gauge reading.	Repair/replace gauge.
	Dirt in vacuum manifold.	Check vacuum manifold for dirt and clean.
	Seed baffle (If applicable) not allowing seed flow due to bridging of seed.	Mix talc thoroughly to coat all seeds. Remove seed baffle. See Row Unit Operation section.
Seed disc worn.	Replace.	
Vacuum seal worn.	Replace.	
Not planting seed.	Seed hoppers empty.	Fill seed hopper.
	Seed tube plugged/damaged.	Clean or replace tube.
	Meter drive damaged.	Repair/replace drive components.
	Low/no vacuum.	Inspect vacuum system and repair as necessary.
	Singulator blade setting too aggressive.	Adjust singulator blade.
	Faulty vacuum gauge.	Repair/replace vacuum gauge.
	Seed bridging in hopper.	Add graphite to improve seed flow.
	Loss of vacuum at meter.	Check for foreign material between vacuum cover and disc. Inspect parts for wear/ damage. Clean and/or replace as required.
	Wrong seed disc.	Use appropriate disc for seed type and size.
	Meter drive clutch not engaged.	Engage drive clutch.
	Fan not running.	Start fan.
Dirt in vacuum manifold.	Check vacuum manifold for dirt and clean.	

Continued on next page.

VACUUM SEED METER - Continued

PROBLEM	POSSIBLE CAUSE	SOLUTION
Not planting seed. (Continued)	Seed baffle (if applicable) not allowing seed flow due to bridging of seed.	Mix talc thoroughly to coat all seeds. Remove seed baffle. Row Unit Operation section.
	High vacuum.	Adjust vacuum level to appropriate level.
	Wrong seed disc.	Replace seed disc.
	Singulator setting not aggressive enough.	Adjust singulator.
	Faulty vacuum gauge.	Check gauge line for dirt/obstruction. Repair/replace vacuum gauge.
Poor seed spacing.	Obstruction in seed tube.	Clean seed tube.
	Dirty/damaged seed disc.	Inspect seed disc for damage, foreign material in orifices or seed treatment buildup in recesses. Clean or replace.
	Wrong vacuum setting.	Adjust vacuum to appropriate level.
	Excess foreign material in seed.	Inspect and clean meter and seed discs. Use clean, undamaged seed.
	Incorrect singulator setting.	Adjust singulator to appropriate setting.
	Inconsistent driveline.	Inspect drive components for rust, misalignment, worn or damaged parts. Replace/repair as required.
	Toolbar not level or wrong height.	Adjust hitch to level toolbar and row units.
	Planting too fast for conditions.	Reduce speed.
	Rough field conditions.	Reduce speed.
Irregular seed population.	Driving too fast.	Reduce speed.
Unable to achieve desired vacuum level.	Tractor hydraulic flow set too low.	Increase flow to fan motor.
	Incorrect hydraulic connections.	Check all hydraulic connections and hose routings.
	Damaged fan components.	Inspect motor and impeller for wear/damage and repair/replace as necessary.
	Vacuum hose pinched/kinked/blocked.	Inspect air lines for any damage or obstruction. Clean air lines and manifold by removing end cap from manifold and running fan at high speed.
	Vacuum hose loose/disconnected.	Inspect and reattach all air hoses.
	Tractor not producing required hydraulic flow/pressure.	Have tractor serviced by qualified technician.
	Dirt in vacuum gauge line.	Check gauge line for dirt/obstruction and clean.

Kinze Manufacturing, Inc.

I-80 at Exit 216 North, Williamsburg, Iowa 52361